

BENTOMAT[®] CL, 600CL & CLT GCLs

A COMPLETE GUIDE FOR THE PROPER DESIGN AND CONSTRUCTION OF WATER CONTAINMENT SYSTEMS



BENTOMAT® CL and CLT GCLs

CONTENTS

SECTION 1 INTRODUCTION	4
1.1 Purpose and Scope	4
1.2 Limitations	4
1.3 Disclaimer	4
SECTION 2 UNIVERSAL DESIGN PARAMETERS	4
2.1 Site Selection	4
2.2 Slope Stability	5
2.2.1 Internal Shear Strength	6
2.2.2 Interface Shear Strength	6
2.2.3 Recommended Slope Angle	8
2.2.4 Steeper Slopes	8
2.2.5 GCL Orientation	9
2.2.6 General Design Guidelines for Slope Stability	9
2.2.7 Anchorage of the Liner	10
2.3 Hydraulic Performance	10
2.3.1 Performance Requirements	10
2.3.2 Darcy's Law for Clay Liners	10
2.3.3 Baseline Hydraulic Performance	11
2.3.4 Seam Flow	11
2.3.5 Safety Factors for Installation Damage	12
2.3.6 Net Hydraulic Performance	12
2.3.7 Evaporation	12
2.4 Chemical Compatibility	13
SECTION 3 APPLICATION-SPECIFIC DESIGN CONSIDERATIONS	13
3.1 Wastewater Lagoons or Sedimentation Basins	13
3.1.1 Inlet / Outlet Structures and Penetrations	13
3.1.2 Sludge and Sediment Removal	14
3.1.3 Designing for Water Level Fluctuations	14
3.1.4 Gas Venting	14
3.2 Fire Ponds	14
3.2.1 Water Usage	14
3.3 Wetlands	14
3.3.1 High Groundwater Conditions	15
3.3.2 Consolidation of Subgrade	15
3.3.3 Cut and Cover Construction	15
3.3.4 "Bottomless" wetlands and ponds	16
3.3.5 Streams and wetlands	16
3.4 Canals	16
3.4.1 Slope Stability	16
3.5.1 Pond Shape and Geometry	16
3.5.2 The Pond Foundation	16
3.5.3 The Pond Perimeter	17
3.5.4 Boat Ramps	17
3.5.5 Vegetation	17
3.5.6 Rockstructures	17

SECTION 4 LINER INSTALLATION	18
4.1 Equipment	18
4.2 Shipping Unloading and Storage	19
4.2.1 Shipping	19
4.2.2 Unloading	19
4.3 Subgrade Preparation	19
4.3.1 Unstable Subgrade Conditions	20
4.4 Liner Deployment	20
4.4.1 Basic Placement Guidelines	20
4.4.2 Placement Strategies	20
4.5 Anchorage	21
4.6 Seaming	21
4.7 Sealing around Penetrations and Structures	22
4.8 Damage Repair	22
4.9 Covering the Liner	22
4.9.1 Cover Thickness	23
4.9.2 Cover Placement	23
4.9.3 Cover Type	23
4.10 Cover Soil/Stone Stability	23
4.10.1 Erosion Prevention	24
4.10.2 Alternative Cover Materials	24
4.11 Weather	24
4.12 Construction Quality Assurance (CQA)	24
SECTION 5 OPERATION AND MAINTENANCE	25
5.1 Initial Filling	25
5.2 Sludge and Sediment Removal	25
5.3 Performance Monitoring	25
5.4 Inspections	26
5.5 Addressing Leaks	26
REFERENCES	27
APPENDIX A – Estimating the Effects of Preferential Seam Flow on Liner System Performance	28
APPENDIX B – Evaporation Nomograph	32
APPENDIX C – Example Calculation for Slope Stability	34
APPENDIX D – Ramp Design Procedure	38
APPENDIX E – Pond Liner Design Checklist	40
APPENDIX F – Guidelines for Assessing the Condition of Hydrated Liner	41
APPENDIX G – BENTOMAT CL and CLT Interface Shear Test Data	42

ACKNOWLEDGEMENTS

The information in this manual has been compiled using the many years of experience and insights accumulated by CETCO personnel and our dedicated team of sales professionals. Special acknowledgment is reserved for Joe Carmo who pioneered many of the design strategies for water containment that are covered in this manual.

NOTICE: THIS DOCUMENT IS INTENDED FOR USE AS A GENERAL GUIDELINE FOR THE DESIGN OF CETCO GCLS. THE INFORMATION AND DATA CONTAINED HEREIN ARE BELIEVED TO BE ACCURATE AND RELIABLE. CETCO MAKES NO WARRANTY OF ANY KIND AND ACCEPTS NO RESPONSIBILITY FOR THE RESULTS OBTAINED THROUGH APPLICATION OF THIS INFORMATION. DESIGN GUIDELINES ARE SUBJECT TO PERIODIC CHANGES. PLEASE CONSULT OUR WEBSITE FOR THE MOST RECENT VERSION.



Figure 1-1. A properly designed and constructed artificial pond is functional and aesthetically pleasing.

BENTOMAT® CL and CLT GCLs

SECTION 1 INTRODUCTION

1.1 PURPOSE AND SCOPE

The primary objective in the design and construction of a pond liner system is water containment. If this objective is not achieved, the resulting empty excavation is a painfully obvious reminder of failure. Unfortunately, the mistakes that cause this failure may be time-consuming, expensive and difficult to correct. The purpose of this manual is to provide the design and installation information necessary to minimize the chance for failure.

This document includes design and construction guidelines for the lining of fresh-water liquid containment systems, including ponds, waste-water lagoons, wetlands, and canals. These structures all have common or “universal” design elements as described in Section 2 of the manual. Section 3 provides additional design considerations that are specific to each type of water containment application. Section 4 provides liner installation procedures, and, finally, Section 5 covers operation and maintenance practices for ensuring long-term performance of the liner system.

It should be noted that this manual provides BENTOMAT CL pond design and installation guidance. In any project, both of these tasks must be performed properly. The best design cannot overcome sloppy execution, nor can a superb installation compensate for a poor design. In other words, liner system design and construction are inextricably linked, and every project should be approached with this concept in mind.

1.2 LIMITATIONS

The information in this manual has several important limitations as listed below:

This manual only considers those design parameters which will directly or indirectly address the performance of the liner system. It does not address other design considerations relating to the local ecosystem, hydrology, safety, seismic activity, and aesthetics.

This manual is to be used only for the design of fresh water containment systems. Different design and product selection procedures apply for the design of containment systems for other liquids, including salt water and brackish water.

The field performance of a pond liner system is typically considered acceptable (under normal, non-critical conditions) even when there is some small amount of leakage. A higher degree of containment may be possible, but is achieved at significant additional expense. It is the designer’s responsibility to define pond leakage performance requirements with this concept in mind.

The design data in this manual applies to BENTOMAT CL, BENTOMAT

CLT, and BENTOMAT 600CL. The design calculations and test data provided in this manual are specific to these products. BENTOMAT CL, CLT, and 600CL are premium pond lining products because of their unique combination of superb performance and field ruggedness. BENTOMAT CL products consist of bentonite encapsulated between woven and nonwoven geotextiles, needle-punched together, with either a smooth flexible polyethylene geofilm (BENTOMAT CL and 600CL) or a double-sided textured HDPE geomembrane (BENTOMAT CLT) laminated to the nonwoven geotextile component of the GCL.

Excessive leakage through a liner system may occur in areas where the liner is damaged or vulnerable to damage. As the depth of the pond increases, the hydraulic pressure also increases, aggressively seeking the “path of least resistance.” Improved performance can be achieved by limiting the maximum water depth to avoid excessive pressure-related leakage. As a general rule, the pond depth should not exceed 16 feet (5 meters). Deeper ponds can be successfully constructed, but more care must be taken with subgrade preparation, installation, and detailing.

BENTOMAT CL, CLT, and 600CL are used only in soil-covered liner systems. Provided with cover, a properly designed and installed liner will function for many years.

1.3 DISCLAIMER

While there may be broad similarities within various pond projects, each project is unique. CETCO does not have the ability to anticipate and control topographical features, soil conditions, weather, installation quality, permitting requirements, and other variables. Therefore, it is the designer’s and installer’s responsibility to recognize these factors and to account for them as necessary. This manual is not intended to be used in lieu of a licensed engineer or architect when required by local and/or state regulations.

The information and data contained herein are believed to be accurate and reliable. CETCO makes no warranty of any kind and accepts no responsibility for the results obtained through application of this information.

SECTION 2 UNIVERSAL DESIGN PARAMETERS

2.1 SITE SELECTION

Several factors should be examined if the designer has the option of selecting the most suitable site for a pond within a given property:

Topography: The area immediately surrounding the footprint of the proposed pond should be fairly level if it is desired to minimize earth-

work. Stormwater should drain away from the excavation rather than into it (locating a pond on a hillside or in a low spot presents some unique challenges with respect to stormwater control). If possible, the top of the pond should be at grade to allow easier access by heavy equipment. Ponds with above-grade perimeter berms are much more difficult to construct.

Soil Type: If information is available regarding the general soil type at the site, check to ensure that the soil:

- Is too porous to be considered acceptable as a barrier. A synthetic liner may not be required if the in-situ permeability of the compacted subsoil is 1×10^{-7} cm/sec or lower. See Section 2.3.2 for more information on assessing the suitability of native soils for use as a liner material.
- Can be compacted properly at the elevation of the proposed subgrade.
- Is not excessively rocky. Rocky subgrades can damage the liner. Rocks larger than 4 in. (100 mm) should be covered with fine-grained soil or screened out and discarded. The rocks remaining in the soil should not be allowed to protrude above the surrounding subgrade (see Section 4.3).
- Is chemically compatible with BENTOMAT CL (see Section 2.4).

Utilities: Underground utility lines must be located and staked. The pond should never be located over the right-of-way of any such utilities. Overhead utilities should also be inspected to ensure that heavy equipment will not contact power lines.

Dammed Streams: Water storage ponds for agricultural use are often sited within an existing streambed or drainage ditch. Caution should be exercised to ensure that the streambed has the bearing capacity to withstand loading during and after construction. If the downstream end of the channel is dammed to create a retention area behind the embankment, these bearing capacity issues are even more important. While a foundation analysis is beyond the scope of this document, any soil mechanics textbook can be consulted for proper design procedures.

Depth to Water: The depth to the seasonal high water table should also be known. Failure to understand local hydrogeological conditions could seriously affect construction. Excavating into the water table will make subgrade preparation and compaction almost impossible. Even if water infiltration does not occur, it may be impossible to obtain adequate compaction if the subsoils are continuously saturated. Dewatering may be required (Section 3.3.1). Hydrostatic uplift of the liner system is another concern in conditions where the elevation of the groundwater table exceeds the elevation of the water in the pond. This condition will generate an uplift force which may exceed the confining stress on the liner. For these reasons, an unsaturated zone of at least 6 feet (2 m) should exist between the bottom elevation of the pond and the top of the seasonal higher water table. If it is not possible to achieve these conditions, the pond will be more difficult to construct. Section 3.3.1 of this manual discusses strategies for managing high groundwater levels.

Trees: While trees near the pond may be aesthetically pleasing, they can interfere with construction equipment. Tree roots can make subgrade preparation difficult and affect the liner in the long term. In a completed pond, falling leaves can contaminate the water. For these reasons, trees should be set back from the perimeter by at least 20 feet and perhaps more for certain tree species.

2.2 SLOPE STABILITY

Special Note: Many useful stability modeling techniques have been developed (Koerner and Soong, 2005; Giroud and Beech, 1989; Wilson- Fahmy and Koerner, 1992; Long, et. al., 1994, to name a very few) which expertly address this paramount design concern. This paper does not endorse a particular mathematical method for calculating the design shear load on the liner system and determining its stability. Instead, the manual provides design guidance based on previous project experience, large-scale laboratory shear test data, and conservative engineering assumptions. This approach is possible because the cross-section of the liner system is relatively constant (BENTOMAT CL is placed over a prepared soil subgrade, and a 1 foot (300 mm) soil/stone cover layer(s) is placed over the liner). For cases where the design of the slope departs from the established guidelines, a more quantitative method for assessing stability is presented in Appendix C.

Furthermore, this paper does not provide guidance for assessing global slope stability, relating to the stability of the soil beneath the liner. It is assumed that the site selection process has resulted in the location of the pond in an area with stable soils. Global stability considerations can be evaluated through several textbook methods. A useful summary of these considerations is found in Koerner (1994).

Most water containment applications require placement of the liner on a sloped surface. When a protective soil/stone layer is then placed over the liner, the weight of that cover induces a downslope shear (driving) force on the layers beneath it. The primary engineering challenge in this situation is to ensure that the driving force does not exceed the frictional resisting forces between each component of the liner system. If this condition is not met, a slide may result. The consequences of a slide are generally severe and can result in failure of the liner. The

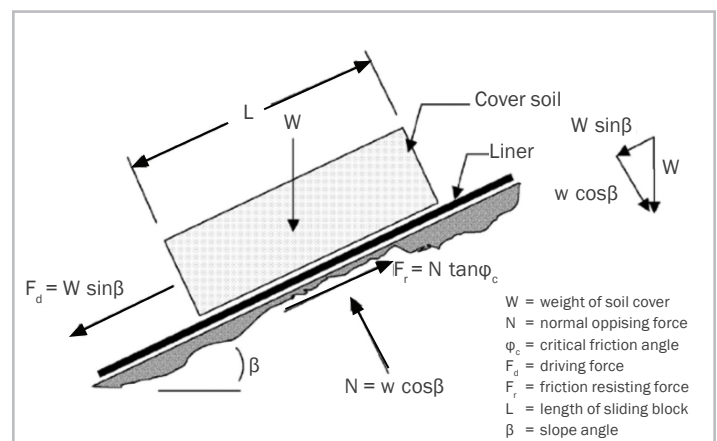

Figure 2-1. Sliding Block Slope Stability Analysis.

BENTOMAT® CL and CLT GCLs

information in this section of the design guide will assist engineers in designing to prevent sliding failures.

As shown in Figure 2-1, the driving force is the slope-adjusted weight of the cover layer(s).

The resisting force is the frictional resistance between adjacent layers or interfaces of the liner system and the overlying cover soil. A low-friction interface will therefore provide little frictional resistance and could cause instability. It is important to note that a liner system may still be stable even if the resisting force is smaller than the driving force. This is because additional contributions to the total resisting force may be provided by the “buttress effect” of the cover material at the base of the slope, and by the tensile strength of the liner anchored at the top of the slope. Appendix C provides a method of determining stability in consideration of these additional resisting components.

By eliminating the buttress effect and the tensile reinforcement effect, the slope stability problem is reduced to a simple comparison between downslope driving force and frictional resisting force. This simplified (yet conservative) approach allows the use of historical interface shear testing data to build general design rules that provide the necessary factors of safety to account for site-specific variations in materials characteristics. In cases where the design factor of safety from the simplified sliding block analysis is insufficient, it may be desired to include the additional resisting forces offered by toe buttressing and the tensile strength of the liner.

2.2.1 INTERNAL SHEAR STRENGTH

The first bentonite liners on the market in the mid-1980s were unreinforced, meaning that the internal shear strength of the liner was no greater than the low shear strength of the hydrated bentonite layer (around 8 degrees). The resulting design process was, therefore, relatively straightforward, although quite limiting due to low shear strength of bentonite. When needlepunched products were introduced in the late 1980s, peak internal shear strength properties were significantly increased. These products can safely be placed on much steeper slopes.

BENTOMAT CL and BENTOMAT CLT are both certified to internal shear strengths of 500 psf under a normal stress of 200 psf, yielding a peak secant friction angle¹ of 68.2 degrees minimum. Because this value

is nominally higher than the interface friction angles discussed in the following section, internal shear strength is not a relevant design issue in most liquid containment projects. Only when normal stresses are quite large (in excess of 10,000 to 12,000 psf or 480–575 kPa) do resultant shear stresses approach the internal strength limits of BENTOMAT CL/CLT reinforced liners. For this reason, the lowest peak interface strength is the critical design parameter. Since the peak internal shear strength of the GCL will rarely be mobilized (only under large normal stresses), the large displacement internal shear strength of the GCL is typically not relevant.

Internal shear strength must be demonstrated both in the short term and the long term, ideally for the life of the pond. Laboratory research (Trauger, et. al., 1996) indicates that the needle-punched reinforcement can sustain long-term shear loads. In one test, total displacement was essentially negligible after 10,000 hours of exposure to a constant shear load of 250 psf (12 kPa) and a normal load of 500 psf (24 kPa). Laboratory testing by Zanziger and Sothoff (2012) estimated that the needlepunch reinforcement of BENTOMAT would have a lifetime of more than 100 years. In addition to the laboratory research referenced above, field-scale testing (Koerner, 1996) and actual project experience have yielded similar conclusions. From the data and experience gained to date, it is reasonable to conclude that BENTOMAT CL will maintain significant internal strength in the long term.

When shear strength is not important (such as pond bottoms) BENTOMAT 600CL can be installed. BENTOMAT 600CL is a lightly reinforced GCL and is not intended for sloped applications. BENTOMAT 600CL should only be installed on flat areas, 10H:1V or less.

1. The secant angle is calculated by taking the inverse tangent of the shear strength divided by the normal stress applied to the system. In an infinite slope analysis, the slope is generally stable if the friction angle is greater than the slope angle.

2.2.2 INTERFACE SHEAR STRENGTH

A thorough stability analysis requires evaluation of all the interfaces in the liner system. Ideally, each interface should be capable of generating enough friction to transfer the driving force rather than creating tension on the liner.

CETCO ran representative interface shear strength tests with various soils against both BENTOMAT CL and BENTOMAT CLT. Interface shear strength tests with various soils were conducted against the smooth geofilm interface of BENTOMAT CL, the woven geotextile component of

SOILS TESTED AGAINST GEOFILM SIDE OF BENTOMAT CL					
SOIL TYPE	NORMAL STRESS (PSF)	PEAK SHEAR STRENGTH (PSF)	PEAK SECANT ANGLE	RESIDUAL SHEAR STRENGTH (PSF)	RESIDUAL SECANT ANGLE
Silty Sand (SM)	400	166	22	152	20
Clay (CL)	400	206	27	195	26
Graded Aggregate Base (GAB)	400	195	26	184	24
Average			25		23

Table 2-1. Summary of interface shear strengths of various soils and BENTOMAT CL's geofilm interface, tested under low normal stresses typical of a water containment application (test results included in Appendix G).

SOILS TESTED AGAINST WOVEN GEOTEXTILE SIDE OF BENTOMAT CL					
SOIL TYPE	NORMAL STRESS (PSF)	PEAK SHEAR STRENGTH (PSF)	PEAK SECANT ANGLE	RESIDUAL SHEAR STRENGTH (PSF)	RESIDUAL SECANT ANGLE
Silty Sand (SM)	400	294	36	244	31
Clay (CL)	400	327	39	283	35
Graded Aggregate Base (GAB)	400	402	45	291	36
Average			40		34

Table 2-2. Summary of interface shear strengths of various soils and BENTOMAT CL's woven geotextile interface, tested under low normal stresses typical of a water containment application (test results included in Appendix G).

In certain scenarios, particularly on steep and/or long slopes, the shear strength between the soil and the geofilm component of BENTOMAT CL may not be enough. In these cases, BENTOMAT CLT may be more appropriate. The following test results are representative of the interface shear strength between soils and the textured HDPE geomembrane component of BENTOMAT CLT:

SOILS TESTED AGAINST TEXTURED GEOMEMBRANE SIDE OF BENTOMAT CLT					
SOIL TYPE	NORMAL STRESS (PSF)	PEAK SHEAR STRENGTH (PSF)	PEAK SECANT ANGLE	RESIDUAL SHEAR STRENGTH (PSF)	RESIDUAL SECANT ANGLE
Silty Sand (SM)	400	213	28	178	24
Clay (CL)	400	290	36	177	24
Graded Aggregate Base (GAB)	400	257	33	214	28
Average			32		25

Table 2-3. Summary of interface shear strengths of various soils and BENTOMAT CLT's geomembrane interface, tested under low normal stresses typical of a water containment application (test results included in Appendix G).

BENTOMAT CL, and the textured geomembrane interface of BENTOMAT CLT. The woven geotextile component of BENTOMAT CL and BENTOMAT CLT is the same.

As in the internal shear strength, the amount of friction for a given combination of soil and/or geosynthetic layers can be expressed as an angle. Interface shear tests under normal loads of 400 psf were conducted, representative of cover soil conditions, and friction angles were calculated for each interface. As mentioned above, other factors such as buttressing and soil tapering can be taken into consideration to meet a desired factor of safety against sliding. The following test results are representative of BENTOMAT CL. Project specific testing is recommended for more accurate analysis.

From this data, some important conclusions can be drawn about the interface shear strength properties of this liner and different soils. There is significant variation in peak interface friction values, which emphasizes the fact that every soil has unique characteristics which should be considered independently of historical data.

In the case of BENTOMAT CL, the interface between the soil and the geotextile side of the liner is higher than the interface between the geofilm and the soil. This means that the "critical" or weakest interface will usually be the subgrade against the liner, assuming that BENTOMAT CL is installed geofilm side down. In the case of BENTOMAT CLT, the test results showed the woven geotextile component would still produce a higher peak shear strength compared to the geomembrane side; however, that difference is much narrower.

In the case of BENTOMAT CL, there is little difference between the peak and post-peak shear strengths, meaning that shear displacement of these interfaces does not cause significant loss of strength. This essentially eliminates the problem of trying to decide whether to design around peak or post-peak strengths. BENTOMAT CLT does experience some loss of strength between peak and post peak strength. In certain conditions (such as seismic events or construction loads), the peak strength may be exceeded, and the post peak strength would be mobilized. In these scenarios, the design engineer may consider checking slope stability with the post-peak interface shear strength value.

BENTOMAT® CL and CLT GCLs

2.2.3 RECOMMENDED SLOPE ANGLE

Given the simplifying assumptions described previously, the slope stability problem becomes a textbook “sliding block” where the forces acting on the slope are the same in all locations. This means that the stability of a proposed system can be determined simply by comparing the interface friction angle between various liner system components to the design slope angle. If the lowest (“critical”) interface friction angle in the liner system exceeds the slope angle, the slope will generally be stable. If the lowest interface friction angle is less than the slope angle, the slope is potentially unstable and a sliding failure is possible. The analysis can also include a safety factor, which is the ratio of the resisting force to the driving force. From Figure 2-1 it can be seen that:

$$FS = \frac{W \cos \alpha \tan \phi_c}{W \sin \alpha} \quad (\text{Equation 2-1})$$

Which through trigonometric identities can be simplified to:

Where:

$$FS = \frac{\tan \phi_c}{\tan \beta} \quad (\text{Equation 2-2})$$

- FS = Factor of safety
- ϕ_c = Critical (lowest) friction angle in lining system
- β = Slope angle

It is emphasized that this method assumes zero cohesion in the cover soil (sand is an example of a cohesionless soil) and zero seepage (pore pressure) forces, and only applies to simple slope veneers of uniform depth along the slope. Cohesive soils tend to increase stability, so zero cohesion is considered a conservative assumption in any cases where the cover soil exhibits some cohesion. It is also noted that this method of analysis does not include slope length, because the sliding block exerts the same forces on any part of the slope. The method used in Appendix C should be used in cases where the sliding block analysis is inconclusive.

EXAMPLE: A pond is designed with an interior side slope 20 feet long and with a grade of 4H:1V. Using BENTOMAT CL with a silty-sand cover soil layer one foot thick, is this slope stable?

ANSWER: From Appendix C, Table C-2, a 4H:1V slope is 14.0 degrees. From Table 2-1, the typical expected interface shear strength on the GCL (ϕ_c) is 22 degrees (Geofilm side of BENTOMAT CL to silty-sand). Using Equation 2-2:

$$FS = \frac{\tan \phi_c}{\tan \beta} = \frac{\tan(22)}{\tan(14)} = 1.6$$

For this type of application, a factor of safety of 1.6 is considered quite acceptable and therefore the slope is stable.

Based on the data provided above, **CETCO recommends that the maximum slope angle should not exceed 4H:1V or 14 degrees when using BENTOMAT CL.** The design of a liner system with this slope angle will provide stability with a factor of safety of approximately 1.5 when the minimum interface friction angle in the liner system is greater than or equal to 20 degrees.

In addition to contributing to stability, there are several other benefits associated with the design and construction of a slope that is $\leq 4H:1V$:

- Natural appearance
- Reduced possibility for erosion-related damage to the cover layer
- Less maintenance of the cover materials
- Easier accessibility to and escape from the shoreline for waterfowl or for recreational use
- Easier installation of the liner and other layers in the liner system
- Easier subgrade preparation and compaction

For these reasons, a designer should make a reasonable effort to limit the slope steepness of a pond to a maximum of 4H:1V. This assumes that the GCL is BENTOMAT CL, deployed with the geofilm side facing up. When the slope exceeds 4H:1V, other variables can be taken into consideration, as discussed below.

2.2.4 STEEPER SLOPES

It may be necessary to design the pond using slopes steeper than 4H:1V in order to obtain the necessary water volume or depth within a given area. In such cases, the simplified stability analysis presented above will show that the slope is potentially unstable, or at least will not provide a factor of safety of 1.5. BENTOMAT CL may also be used for steeper slopes, in which case a more rigorous stability analysis is required to determine if this is really the case. Appendix C provides a detailed review of this method, and the results show that the liner system can be stable on a steeper slope as summarized in Table 2-4.

Slopes steeper than 4H:1V can also be made stable by installing BENTOMAT CLT instead of BENTOMAT CL and/or by using reinforcing members (such as geogrids or reinforcing geotextiles) to carry the weight of the protective cover. The same simplified analysis above can be repeated for BENTOMAT CLT. If the minimum interface friction angle with the cover soil is at least 27 degrees, a factor of safety of 1.5 can be achieved with a 3H:1V slope with BENTOMAT CLT.

If reinforcement is used, it would be separately anchored at the top of the slope and would interlock with the cover layer more efficiently than the original interface. Where synthetic reinforcement is necessary, a more extensive stability analysis is required which is best performed by an experienced engineer or vendor of reinforcement systems. An example analysis method for slopes with veneer reinforcement is provided by Koerner & Soong (2005). Reinforced slopes are technically feasible, but project costs could be significantly greater than if it is decided to grade the slope more moderately.

A mid-slope “bench” can also be considered for certain steep slope applications. A horizontal shelf or bench on the slope will provide but-

trekking of the cover soil above it, allowing steeper slopes to be accommodated. The analytical method in Appendix C can be used to evaluate the benefits of a mid-slope bench.

2.2.5 GCL ORIENTATION

Installing BENTOMAT CL with the geofilm side facing upward should result in a stable system on most 4H:1V slope systems. On steeper slopes, BENTOMAT CL is frequently installed with the geofilm side facing down against the subgrade to provide for improved slope stability. In this orientation, BENTOMAT CL may go into tension. With the support of an anchor trench at the top of the slope, and the addition of a “buttress effect” provided by the cover material at the toe of the slope, the system can still be stable, as discussed in the following sections.

However, in certain cases, it may be preferable to install BENTOMAT CL or CLT with the geofilm or geomembrane facing upward. This may be the case when the GCL is expected to undergo wetting and drying cycles, such as dry detention ponds. Installing BENTOMAT CL with the geofilm side facing up will help allow the bentonite to maintain its moisture, even during periods of drought. Bentonite that undergoes wetting and drying cycles can experience an increase in long-term hydraulic conductivity, depending on the chemistry of the adjacent soil material. Much of this research is related to GCLs in cover applications, where GCLs can experience the combined effects of desiccation and ion exchange. Installing BENTOMAT CL with the geofilm facing up will help prevent the bentonite from desiccating, and allow a lower overall permeability through BENTOMAT CL. More on this topic can be found in CETCO’s TR-341.

Another scenario where it may be more favorable to install the GCL with the geofilm side facing up is where erosion of the bentonite is a

concern. This may be in a river or stream where the water current may erode the bentonite. Installing the GCL with the plastic side facing up would protect the bentonite from the moving water.

Installing BENTOMAT CL with the geofilm side facing up is typically recommended for slopes up to 4H:1V. If slopes are steeper, and installing with the geofilm side facing up is preferable, BENTOMAT CLT should be considered for improved slope stability. This will be discussed further in the following sections.

2.2.6 GENERAL DESIGN GUIDELINES FOR SLOPE STABILITY

Assessing the stability of lined slopes for a pond application can be a confusing task from a strictly mathematical standpoint. This is because many variables are required to perform the calculations. Fortunately, the confusion can be minimized if we examine only the relevant data and site conditions expected for a pond. In order to develop some simplified slope stability guidelines, it is assumed:

- BENTOMAT CL is used for lining the pond, installed with the geofilm facing down.
- The soil cover layer is 1.5 feet (450 mm) thick, has a unit weight of 130 lbs/ft³ (20.4 kN/m³), and an internal friction angle of 34 degrees. This accounts for the possibility that some ponds will require thicker cover layers than others.
- The interface friction angle of the geofilm component of BENTOMAT CL against the subgrade is the critical interface and is 20 degrees.
- The desired safety factor is 1.3.

Using these assumptions, and the analytical method in Appendix C, the following general rules are established for BENTOMAT CL:

SLOPE GRADE	SLOPE ANGLE (DEG)	MAXIMUM ALLOWABLE SLOPE LENGTH, FT (M)	COMMENT
Up to 4H:1V	0 – 14	Any	No stability concerns when the slope is 14 degrees or less.
Up to 3H:1V	18.4	67 (20.4)	With 3 ft (1 m) of freeboard this allows a water depth of 18 feet (5.4 m).
Up to 2.5H:1V	21.8	30 (9.1)	Liner will be in tension on a 2.5H:1V slope.
Up to 2H:1V	26.6	17 (5.2)	Maximum slopes on any project should not exceed these values.

Table 2-4. Recommended maximum slope lengths for pond lining applications with BENTOMAT CL, when installed geofilm-side down and anchored at the slope crest. See important notes below:

Important Notes:

1. Submerged slopes are subject to sliding due to wave action, scouring, etc. See Section 3.
2. Method of Giroud and Beech (Appendix C) used to determine slope lengths for steep slopes.
3. This table is to be used as a guideline only. Site-specific evaluations should always be performed, most notably for slopes steeper than 4H:1V.

Using this table as a guideline, it should be possible to design and construct lined slopes that will be stable in the long term.

Where longer/steeper slopes are lined, BENTOMAT CLT can be utilized in place of BENTOMAT CL. Site specific shear strength testing is highly recommended for slopes greater than 4H:1V, followed by a slope stability analysis to ensure a sufficient factor of safety against sliding. Please contact CETCO for material samples for testing. CETCO can also suggest third party testing laboratories that are experienced with these test methods.

BENTOMAT® CL and CLT GCLs

2.2.7 ANCHORAGE OF THE LINER

It is standard practice in the synthetic lining industry to place the end of the liner into an anchor trench at the top of a slope. The anchor trench prevents the liner from moving during, and in some cases, after construction. In the most conservative design, no tension exists on the liner, and an anchor trench only serves to prevent unintended liner movement during placement of the cover soils. However, Table 2-4 indicates that the liner system can be in tension under certain conditions of slope steepness and loading. In these cases, the anchor trench plays an important role in ensuring stability of the liner system. The trench must therefore provide enough resistance to prevent the liner from pulling out and sliding down slope.

Koerner (1994) provides a detailed model for designing an anchor trench based on the amount of tension allowed on the liner. From Appendix C, the allowable strength of BENTOMAT CL is 312 lbs/ft (4.6 kN/m). With a typical in-service liner thickness of 0.4 inch (1 cm), the allowable stress is 65 lbs/in² (450 kPa). Using Koerner's methods it can be calculated that an anchor trench with a **2 foot (60 cm) runout at the top of the slope and a 1 foot (30 cm) depth** is adequate to accommodate the stresses that may be imposed on the liner in certain conditions.

2.3 HYDRAULIC PERFORMANCE

The purpose of the pond liner is to function as a barrier to water. As a result, the baseline hydraulic performance of the liner must be demonstrated to meet any design or regulatory requirements under the anticipated service conditions. This section of the design guide identifies realistic performance objectives for a pond liner system and provides the tools needed to estimate how much leakage can reasonably be expected from a typical pond lined with BENTOMAT CL, CLT, or 600CL.

The first step in determining the anticipated hydraulic performance is to identify the service conditions to which the liner will be exposed. The term "service conditions" includes the following:

- Confining stress – the weight of cover material on the liner system
- Hydraulic head – the depth of water on the liner system
- Other factors which could influence liner system performance in the long term, such as climatic exposure, maintenance activities, chemical degradation, etc.

With knowledge of these service conditions, performance of the liner system can be estimated. Permeability or hydraulic conductivity has historically been used to measure the hydraulic performance of liners. The permeability of a liner is not the same as its leakage rate, however. In order to calculate the leakage rate, or flux, of a liner, the service conditions described above must be known. Then, a relationship known as Darcy's Law can be used to calculate the leakage rate. This is discussed in Section 2.3.2.

2.3.1 PERFORMANCE REQUIREMENTS

The design objective for many ponds is usually no more sophisticated than to ensure that it "holds water." Obviously, a more quantitative design process is needed, not only to meet any existing performance re-

quirements but also to establish a realistic set of expectations regarding the containment ability of a pond.

On one extreme, we can assume that zero leakage is not a reasonable design goal. First, it would seldom be considered necessary, except in cases where an extremely hazardous waste is being contained. Such systems are beyond the scope of this manual. Second, the cost of obtaining a zero leakage pond would be astronomical, in consideration of the many redundancies that would be required to ensure that no water escapes. And finally, as with any human endeavor, it can be argued that "perfection" in the form of zero leakage is not even possible.

On the other extreme, the pond must not leak to the extent that the static water level visibly decreases or is held constant only by adding large volumes of makeup water. In consideration of these two extremes, it can be seen that the performance objective should involve some sort of equilibrium where feasibility, cost, and containment intersect. Through a closer examination of the techniques used to measure hydraulic performance, we will develop a quantitative performance equilibrium point that should be adequate for most ponds.

The nature of the subgrade soils and water table also play a role in determining how effective the liner should be. For example, a liner installed over a clayey subgrade may have several defects without showing excessive leakage. If those same defects were present over a sandy subgrade, however, there would likely be much more leakage. The depth to the groundwater table at the site can also influence the performance of the liner in a similar way. As a result of these practical complications, the design of an acceptable liner system for water containment involves evaluation of not just the liner material but also the surrounding soils and water levels.

2.3.2 DARCY'S LAW FOR CLAY LINERS

Prior to the introduction of synthetic lining products, most water containment structures were designed and constructed using low-permeability clay soils. Today, earth-lined ponds are still built in large numbers in locations where clay soils are found. In cases where a performance requirement is established for clay-lined ponds, the in-place permeability of the clay soils is usually specified as 1×10^{-7} cm/sec (1×10^{-9} m/sec). This is not the result of back-calculation from some existing leakage requirement; instead, it represents a value that can be achieved when a clay soil of good quality is compacted at or near its maximum density under optimum moisture conditions.

Darcy's Law describes the flow through a porous media such as sand, silt, or clay. With knowledge of the service conditions of the liner system, the theoretical leakage rate can be calculated. The following example shows how Darcy's Law can be applied to a clay-lined pond. The resulting leakage value will indicate the relative performance value that clay-lined ponds are capable of achieving and will therefore serve as a reference point for evaluating the performance of other lined ponds.

EXAMPLE: What is the leakage from a clay liner 2 feet (0.6 m) in thickness with a nominal depth of water of 10 feet (3m)?

$Q = kiA$, where

Q = flux through the liner, liters/day

k = hydraulic conductivity, 1×10^{-9} m/sec

= hydraulic gradient, dimensionless

$$i = \frac{\text{hydraulic head} + \text{liner thickness}}{\text{liner thickness}} = \frac{3.0 + 0.6}{0.6} = 6.0$$

A = liner area, assume as $10,000 \text{ m}^2$ (1 ha)

$$\begin{aligned} Q &= (1 \times 10^{-9} \text{ m/sec})(6.0)(10,000 \text{ m}^2/\text{ha})(1,000 \text{ L/m}^3)(86,400 \text{ sec/day}) \\ &= 5,184 \text{ liters/Ha-day} \\ &= 552 \text{ gal/acre/day} \\ &= 0.5 \text{ mm/day} \\ &= 0.02 \text{ inches/day} \end{aligned}$$

There is a long historical precedent for considering the above leakage rate to be acceptable. This is partly because of the difficulty in compacting clay soils to the density necessary to achieve a low permeability value. Thus, “acceptable performance” has come to be defined by what was technically feasible in the past. A leakage rate of approximately 5,000 lphd is a useful reference point in this regard, but it does not represent the performance capabilities of a synthetic liner such as BENTOMAT CL, CLT, or 600CL.

2.3.3 BASELINE HYDRAULIC PERFORMANCE

CETCO has worked with different laboratories in an effort to develop reliable estimates of the flux of BENTOMAT CL for design purposes (see Appendix A). It should be noted that these are very low leakage rates that approach the practical limits of the test equipment used to measure and record them, and that the general consensus is that the majority of this measured leakage is around the sides of the specimen. For example, a flux of $1 \times 10^{-10} \text{ m}^3/\text{m}^2/\text{s}$ is equal to just 1 droplet per day. Assuming that limited installation defects occur in the geofilm component of BENTOMAT CL, 600CL or CLT, the liner will allow very little water through the GCL. Through an intact geomembrane, diffusion is the most likely path of water flow, and while diffusion of water vapor through a liner system will contribute to the overall leakage rate, in most cases diffusion is too slow to be considered as a major contributor to leakage (Richardson, 2000). It is noted that the leakage data reported in Appendix A therefore includes both diffusion as well as advection (direct movement) through the liner system.

Darcy’s Law can be used to estimate the leakage through a standard geotextile-based GCL that does not contain a geofilm or geomembrane component. By changing the water depth, flux data can also be plotted as a function of head pressure at a fixed confining stress. Figure 2-4 shows that the flux increases linearly with increasing head pressure. For example, if the average depth of a pond is 3 m, Figure 2-4 predicts that the leakage rate from a traditional GCL will be approximately 18,000 lphd. This leakage rate is far greater than the 5,000 lphd historical performance of compacted clay. Because of its essentially impermeable geofilm component, performing a flux test is quite

difficult on BENTOMAT CL, because the leakage rate is almost too low to measure accurately. Using the certified hydraulic conductivity of $5 \times 10^{-10} \text{ cm/sec}$ for BENTOMAT CL products, the flux rate can be calculated through BENTOMAT CL as well. Using this method with BENTOMAT CL would be conservative, as demonstrated by the low leakage rates measured in Appendix A. Based on this data, it is clear that a traditional geotextile-encased GCL is not recommended as the sole liner for pond applications and **BENTOMAT CL is the preferred liner material** for pond projects.

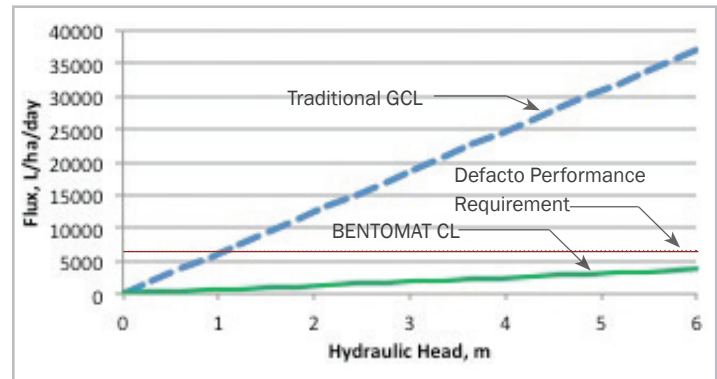

Figure 2-4. GCL flux as a function of head pressure.

It is important to note that other factors can contribute to the hydraulic performance of a standard geotextile-based GCL in high head applications. For instance, where the subgrade is porous, higher hydraulic pressures can force bentonite from the geotextile components, essentially resulting in thin spots in the GCL, or even spots where bentonite is completely forced out. The geofilm or geomembrane component serves two functions – a low permeability barrier on its own, and in limiting bentonite migration through a GCL.

2.3.4 SEAM FLOW

As with any synthetic liner system, the potential for leakage problems are greatest at the longitudinal and lateral seams – where adjacent liner panels are connected. With pond liners such as BENTOMAT CL, there is no mechanical attachment of the panels; they are simply overlapped with a bead of granular bentonite between the panels. Properly installed, the liner should be self-seaming such that the hydraulic performance of the seam is almost the same as unseamed material. To achieve this result, some confining pressure is needed. The cover soil layer(s) provide this confinement, in addition to physical protection of the liner system from equipment, animals, and erosion.

Appendix A provides results with large-scale seam flow testing using BENTOMAT CL under a variety of hydrostatic head pressures from 30 to 90 psi (SGI, 2001). These tests show that the overlapped seam yielded slightly higher leakage than unseamed specimens, as would be expected. The flux through the overlapped seams of BENTOMAT CL will be based on the total seamed area. Assuming a reduced roll length of 100 ft (instead of the standard 150 ft), the design flux for a seamed system of BENTOMAT CL becomes $4.17 \times 10^{-10} \text{ m}^3/\text{m}^2/\text{s} = 360 \text{ lphd} = 38.5 \text{ gpad}$.

BENTOMAT® CL and CLT GCLs

The importance of a proper seam installation cannot be understated. A traditional liner system is typically composed of a low permeability soil and/or a welded geomembrane. A properly welded seam will allow essentially zero leakage. A GCL seam requires careful installation, including a properly prepared subgrade to ensure that the two panels are installed with as few wrinkles as possible and without gaps between the two panels. Improperly installed, water can easily escape the system between the two GCL panels. The installation instructions in Sections 4.3 and 4.6 for subgrade preparation and seam installation should be followed to help ensure a proper GCL installation.

While BENTOMAT CL products allow for expedience and ease of installation, in certain cases, a standard composite system, consisting of BENTOMAT ST with a separate overlying welded geomembrane may be more appropriate. This may apply to large water reservoirs and other critical water containment structures where a higher factor of safety to water loss is required.

2.3.5 SAFETY FACTORS FOR INSTALLATION DAMAGE

This method of analysis does not consider the many imperfections that can occur in any field-constructed liner system and through which much leakage can flow. In fact, with such low baseline leakage in today's generation of synthetic liners, installation quality is the most important factor in determining liner performance. This is yet another variable that is difficult to quantify. The flow through defects in a geomembrane liner (HDPE, PVC, etc.) has been extensively studied by Giroud (1990, 1997). However, the effect of punctures on BENTOMAT CL products has not been specifically studied. With the self-healing attributes of bentonite, a membrane-backed GCL pond liner such as BENTOMAT CL will not suffer dramatic leakage associated with minor geofilm punctures. By assuming a credible scenario in terms of the number and size of defects per unit area of pond, an installation quality safety factor (addressing punctures) may be calculated. Again, there is no information pertaining to the number and size of punctures that occur in the field, but it is assumed that each defect is circular in shape and is 1 cm² (a little less than 1/8") in area. It is further assumed that these punctures are present on every 1,000 m² of pond (10 defects per hectare or 4 holes per acre). Finally, it is assumed that the punctures are self-healing by bentonite, while the punctured membrane freely transmits flow.

As an example, we can refer to Figure 2-4 for a pond that is 6 m deep (this depth is in the range of the baseline flux data obtained at 21 m) to determine the affect of installation damage on the performance of the liner system as a whole. The flux from the damaged portion of BENTOMAT CL is the same as that for BENTOMAT ST, which is 37,000 lphd (3,955 gpad). The total area of the defects is 10 x 1 cm² = 10 cm² = 1 x 10⁻⁷ Ha. The leakage rate through the defects is 108,000 L/Ha/day x 1 x 10⁻⁷ Ha = 0.0037 L/day. This is the total quantity of damage-related leakage in one hectare (2.47 acres) of BENTOMAT CL – lined pond where there are 10 defects per hectare (4 per acre). Compared with the design flux of 360 lphd calculated earlier, it can be seen that minor installation defects (punctures) do not contribute to significant additional leakage.

This finding should not be interpreted as a license to “abuse” the BEN-

TOMAT CL. It only demonstrates that the product can handle, without significant performance deterioration, infrequent punctures that might occur during the installation and covering process. The reason this is acceptable is because the total area of these punctures is very small relative to the total lined area. Installation damage can be more severe than assumed herein and therefore can still contribute a significant amount of the overall leakage of the liner system. The designer must ensure that detailed installation procedures are followed and that the installer recognizes those practices which can damage the liner.

2.3.6 NET HYDRAULIC PERFORMANCE

This analysis of hydraulic performance considers baseline flux, seam flow, and installation damage to arrive at the following design value:

Design Flux through BENTOMAT CL (Q_A) =

$$\begin{aligned}
 &= 4.17 \times 10^{-10} \text{ m}^3/\text{m}^2/\text{sec} \\
 &= 360 \text{ L/Ha/day} \\
 &= 38.5 \text{ gal/acre/day} \\
 &= 0.036 \text{ mm/day} \\
 &= 0.0014 \text{ inches/day}
 \end{aligned}$$

CETCO does not guarantee that these values will be achieved in the field. Actual performance depends on subgrade preparation, installation quality, and other factors discussed in this manual. The values are provided to demonstrate that some small amount of leakage should be included in the liner system design.

It is noted that this leakage rate is far less than the historically accepted pond liner performance standard of 5,000 lphd at 3m head pressure as discussed in Section 2.3.2. It can therefore be concluded that BENTOMAT CL is acceptable for all but the most demanding water containment applications. Certain applications, such as large reservoirs or hazardous waste ponds should still utilize a standard composite liner system, consisting BENTOMAT or RESISTEX® GCL overlain by a separate welded geomembrane for a higher factor of safety against leakage. Regulations may drive this system in some cases.

2.3.7 EVAPORATION

This analysis does not include loss of water through evaporation, which can range from 1–5 mm/day or more in certain climates. An evaporation nomograph (Appendix B) can be used to estimate daily evaporative losses given data on temperature, wind speed, and relative humidity. Of these variables, wind speed has the greatest influence on evaporation. In the United States, a local branch of the National Resources Conservation Service (NRCS) may be able to provide more information regarding evaporation rates. It is interesting to note that evaporative losses can exceed liner flux by a significant margin.

2.4 CHEMICAL COMPATIBILITY

Any liner must have the ability to resist chemical attack when utilized in containment applications where contaminants may be present. Although chemical compatibility is actually a subtopic of hydraulic performance, this issue is worthy of discussion separately from the other hydraulic performance issues presented earlier. The geofilm/geomembrane component of BENTOMAT CL products is not susceptible to attack by any chemicals that would be encountered in normal pond projects. Therefore, this discussion will focus exclusively on the effects of different chemicals on the bentonite component of the GCL.

Sodium bentonite is an effective barrier primarily because it can absorb large quantities of water (i.e., swell). When the bentonite component of the liner hydrates, it becomes a dense, uniform layer with exceptionally low permeability and flux. Water absorption occurs because of the presence of sodium ions situated in the interlayer region between clay platelets.

Experience has shown that calcium is the most common source of compatibility problems for bentonite-based liners. Other cations (magnesium, ammonium, potassium) may also contribute to compatibility problems, but they generally are not as prevalent or as concentrated as calcium (Alther, 1985). Such cations may already be present in the water to be contained or may leach into the water from cover soils on the liner.

CETCO is often asked to specify the maximum concentration at which a certain chemical becomes a compatibility problem. Unfortunately, it is not possible to do so because of the many variables involved in assessing performance. For example, if the bentonite is hydrated in fresh water before exposure to high calcium levels, it will often maintain a low permeability. But the bentonite will not perform as well when initially hydrated in the same calcium solution. In lieu of blanket recommendations, CETCO instead performs project-specific routine compatibility tests that determine if a chemical can affect the liner.



Figure 3-1. Installation of BENTOMAT CL in a typical wastewater lagoon. Inlet pipes in foreground.

The liner may also be sensitive to the chemical composition of soil placed over it. CETCO recommends that limestone and other calcium-rich cover soils be avoided. Another method to overcome compatibility problems is to install BENTOMAT CL with the geofilm facing up. In this orientation, the bentonite will partially hydrate with clean water absorbed from the subgrade and will have very limited exposure to the liquid to be contained. Even if the hydraulic performance of the bentonite is decreased, it can still function effectively in the secondary role of seam-sealing and puncture sealing of the membrane component of BENTOMAT CL. Slope stability of the liner system in this orientation would need to be confirmed. BENTOMAT CLT can help in this regard because of the increased shear strength with the textured geomembrane component.

SECTION 3 APPLICATION-SPECIFIC DESIGN CONSIDERATIONS

Section 2 of this guide discussed design elements applicable to all water containment applications. This section identifies those design considerations that are unique to specific types of applications. By combining universal design elements with application-specific design elements, designers will be able to assemble a comprehensive pond design. Some of these design issues (such as inlet/outlet structures in Section 3.1.1) do pertain to more than one type of application. Designers are therefore encouraged to review all of Section 3.

3.1 WASTEWATER LAGOONS OR SEDIMENTATION BASINS

Wastewater lagoons contain effluent from industrial or municipal wastewater processing operations. Sedimentation and retention basins are designed to store runoff water and to allow suspended solid particles to settle so that clean water can be discharged. BENTOMAT CL may be used as a primary liner, or as a secondary liner beneath a geomembrane in these applications. In either case, there are several issues a designer must consider to ensure proper liner system function.

3.1.1 INLET / OUTLET STRUCTURES AND PENETRATIONS

Wastewater lagoons may have inlet and outlet structures such as manholes, pipes, weirs, or bottom drains. These structures will generally require a penetration in the liner system, especially if a bottom drain is required. All such penetrations must be treated with special care during both the design and installation phases of the project. The hydrostatic pressure exerted by the water column is a tremendous force that will readily exploit any areas that are not secure. Rapid leakage and extensive damage to the pond are possible through a small breach in a containment system (Richardson, 2002; Bierwirth and Richardson, 2003). For this reason, CETCO recommends that lagoons should not have bottom drains, and that the number of penetrations and associated structures be kept to a minimum. A good alternative to pipe penetrations is a

BENTOMAT® CL and CLT GCLs

spillway which allows water to enter or exit the pond in a controlled flow.

CETCO does not generally recommend a physical attachment of the liner to a wall or a penetrating pipe. Instead, a positive seal is formed around the penetration as shown in Figure 4-9. First, a small notch is excavated around the structure into the subgrade. Next, this notch is backfilled with bentonite. Finally, the liner is placed against the structure and is held in place by cover soil (see Section 4.7 for additional details). Because BENTOMAT CL does not thermally expand or contract, there is nothing to be gained by physical attachment of the liner to the structure. Such attachments can cause potential stress points and damage to the liner if there is long-term movement in the structure. A bentonite-based seal can better accommodate such movements while maintaining the hydraulic performance required for this crucial area. In instances where a mechanical connection is desired, contact CETCO for additional installation details.

If buried or above-grade pipes are used in the lagoon, the pipes and joints should be pressure tested for leaks prior to being buried or put into service. This step will help to eliminate one potential source of water loss that could be confused with liner leakage after the pond is put into service.

3.1.2 SLUDGE AND SEDIMENT REMOVAL

The designer must be aware of the long-term use and maintenance of the lagoon. If sludge or sediment will accumulate such that periodic removal actions are required, then the floor and walls of the lagoon must be designed to accommodate vehicle loads. The designer may also need to furnish ramps for vehicle access. A ramp design procedure is provided in Appendix D.

A layer of stone, asphalt, or concrete should be placed on the lagoon bottom to provide physical protection and to serve as an “indicator” layer for equipment operators who reach the lower boundary of the sludge or sediment. If stone is used, it should be roughly 2-inch minus (50 mm) in size in a layer approximately 12 inches (300 mm) thick to ensure that it will be noticed if penetrated. However, a proper cover soil as described in Section 4.9.3 must still be provided directly over the liner to prevent puncture. The indicator layer supplements, but does not replace, the protective cover.

Finally, it should be noted that maintenance activities requiring removal of the water should only be performed when the surrounding groundwater level is known to be below the bottom of the pond. This will ensure that hydrostatic uplift forces do not occur. This issue is explored more fully in Section 3.5.2.

3.1.3 DESIGNING FOR WATER LEVEL FLUCTUATIONS

If water level variations are expected, the side slopes of the lagoon may need to be protected from wave action and erosion along their entire length. Frequent drawdown of the water level will expose interior slopes that, if not protected, will be susceptible to erosion. “Hard armor” such as rip-rap is recommended in these cases, as vegetative cover is not

likely to survive. The use of hard armor will also reduce the risk of seepage forces that promote downslope sliding of the cover.

3.1.4 GAS VENTING

Ideally, the site selected for the lagoon does not expel significant amounts of gas. Gas may be generated through degradation of organic matter or through the expulsion of air during periods of a rising water table. If the uplift forces from beneath the liner exceed the confining pressure above it, the liner can be displaced upwards. Damage to the liner is possible if uplift occurs.

If the soil beneath the liner is porous, gas will take the path of least resistance around the lagoon and will not threaten the liner system. However, if the soils are less porous and less permeable, and if the surface area of the lagoon is large, gas venting may be necessary. The design and placement of the vents depends on the amount of gas that may be generated, which is impossible to predict. CETCO is unaware of any analytical methods to estimate gas production rates from sub-soil; however, Koerner (1994) provides a method for calculating the gas transmissivity requirements for a venting layer that would be placed beneath the liner. Given the lack of good design data to address the venting concern and the potential for long-term degradation and settlement, foremost consideration should be given to selecting a site that does not contain significant organic content.

3.2 FIRE PONDS

Fire ponds must be designed to allow easy access for emergency vehicles. The liner system should be able to withstand rapid drawdown in the event that large quantities of water are needed. As discussed in Section 2, there are unique slope stability considerations relating the seepage forces that can occur when the water level is rapidly reduced. Seepage forces can cause stability problems in this situation, and it is therefore recommended to design hard armor on the side slopes of all fire ponds. Seepage forces may also be reduced by use of a drainage layer beneath the cover soil or by buttressing the toes of the slope.

3.2.1 WATER USAGE

A fire pond must be designed with a scheme for removal of the water in the event of a fire. Water can be extracted in several ways:

- Placement of a suction line directly into the pond
- Placement of a submersible pump into the water
- Access via a standpipe which runs to the base of the pond
- Hard plumbing via piping directly to an outlet at the facility
- Siphoning

The water access point will be determined by the type of facility into which the pond will be placed and the relative hazard level presented if a fire occurs. It is beyond the scope of this design guide to address these issues; however, it should be realized that different facilities will have different means of fire water access, which ultimately requires the access point to be compatible with the liner system.

3.3 WETLANDS

The biological diversity within a wetland environment presents a series of challenging design considerations for the engineer attempting to create an environment that meets the conditions necessary to sustain a balanced ecosystem. A properly designed liner system is an essential component of a wetlands design.

A wetland is an area that is saturated or nearly saturated with water and supports vegetation and wildlife adapted for wet conditions. The design of wetlands usually involves a water balance calculation to ensure that the proper water levels can be maintained on a year-round basis. The most basic wetlands consist of a shallow area that has a low permeability subgrade to provide the moist environment necessary for the propagation of aquatic plants. A more diverse ecosystem is established when changes in elevation provide zones of varying moisture for the establishment of other fauna and flora native to the local environment. Figure 3-2 demonstrates three different zones for plant growth based on different moisture levels, and a fourth deepwater zone for aquatic life. Each zone is established by the amount of fill installed above the liner system. The transition from the deep-water areas of Zone 4 to the low water areas of Zone 3 can be handled in different ways. The liner may be deployed continuously through the transition area or may be terminated at the top of the transition. If slope stability calculations (Section 2.2) determine the liner will be placed under unacceptable strain, an anchor trench should be used. A new length of liner would then be laid over the liner in the anchor trench, terminating at the crest of the slope.

3.3.1 HIGH GROUNDWATER CONDITIONS

High groundwater conditions may require creative design and construction techniques in order to establish a viable liner system. The best way to handle high groundwater is through installation of a dewatering system at the perimeter of the site to decrease the groundwater table below the bottom of the excavation. Local soil conditions will influence the effectiveness of the dewatering effort. Silty soils will resist dewatering and will not provide a structurally sound foundation necessary for long-term liner performance. Sandy, drainable soils will more easily convey the flow of groundwater to pump stations, while maintaining reasonable structural stability and load bearing capabilities.

Another concern in high groundwater conditions is the potential for hydrostatic uplift. If the dewatering system is used only during construction, the water table could rise above the water level in the wetlands, thus causing a buoyant force as discussed further in Section 3.5.2. This is not an uncommon occurrence in wetlands work, where the site may already be poorly drained.

High groundwater conditions are problematic on slopes as well. Water migrating through the subgrade soil and onto the sloping surface of a containment area can cause slope stability problems both during and after construction. The designer should be aware of the potential reduction in interface friction that can occur in these conditions. Installation of a site-wide dewatering system is the best technique for avoiding all of these problems related to subgrade moisture. In cases where site-wide dewatering is not possible, localized use of drainage trenches and drainage geocomposites may be used to allow the liner to be properly deployed and covered.

3.3.2 CONSOLIDATION OF SUBGRADE

On many wetlands projects, it may be difficult to drain the subgrade soils. Therefore, the loading on the subgrade from the weight of the cover soils and the equipment used for its installation will cause consolidation. As water is released from the subgrade soils, it may accumulate in a thin film between the subgrade and bottom of the liner. At this point it will be easy for the liner to slide out of position or for water pressure to be relieved through a seam “blowout.”

To address this problem, the installing contractor can place a non-woven geotextile and a 6-inch (150 mm) sand layer on the subgrade prior to the liner installation. The sand layer should be connected to the site dewatering system. On less critical projects, a series of drainage trenches filled with stone can be easily constructed in the subgrade to funnel flow to the dewatering system. Alternately, geocomposite drainage materials can be deployed over any areas requiring additional drainage. The geocomposite would simply be laid on the subgrade and tied into a drainage trench prior to the installation of the liner. All of these options serve the purpose of removing consolidation water and improving interface stability. A greater-than-normal GCL overlap may also be required when these conditions are encountered.

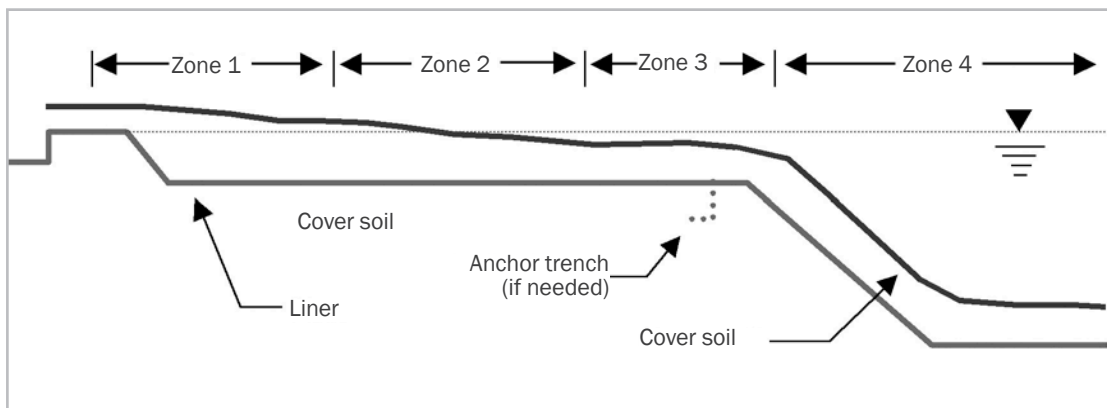

Figure 3-2. The zones within a wetlands will dictate the conditions the liner system will face.

BENTOMAT® CL and CLT GCLs

3.3.3 CUT AND COVER CONSTRUCTION

In wetlands projects, application conditions are often difficult to predict. Designers and contractors may get caught with an unexpected high or low water situation without a ready solution for cost-effectively continuing the installation process. For example, groundwater flow may be so high and so disruptive that it becomes impractical to expose a large subgrade area at any one time. The only possible construction technique is to cut, install liner, and cover in a series of small operations. For this technique to work, the subgrade conditions must be capable of supporting operating equipment without subgrade stabilization.

The characteristics of the cover material placed over the liner are equally important as those of the subgrade soil. The cover should be sufficiently coarse and granular so as to drain freely and support the weight of the covering equipment. In cases where the cover soils are not so stable, it may be preferred to design a geogrid into the system. Experience has demonstrated that the use of a biaxial geogrid above the liner will function to tie the cover system together and provide some consistency when subjected to strain. This technique was used in a 200,000 ft² (20,000 m²) area within a 1,000,000 ft² (100,000 m²) wetlands project where the deep water (Zone 4) areas were several feet below the water table (Trauger and Burgio, 1994).

3.3.4 “BOTTOMLESS” WETLANDS AND PONDS

While it is recommended to line the full surface of a pond to minimize the risk of preferential leakage, it may be possible to use the natural characteristics of a wetlands or pond site to minimize construction costs. For example, a pond site might already possess a layer of clayey soil at a prescribed depth, with acceptable permeability characteristics to function as a bottom liner. In this case, a synthetic liner would be installed only on the perimeter side slopes and would be “keyed” into the clay layer (placed into a trench) at the bottom of the slope in the same manner as the liner is placed into an anchor trench at the top of the slope.

3.3.5 STREAMS AND WETLANDS

BENTOMAT CL is well-suited for the lining of combined environments of wetlands and streams. In these projects, a meandering stream/wetland combination flows to a pond, where a pump recirculates the water back to the beginning of the stream. In any wetlands project, it is necessary to maintain saturation of the soils. This is difficult to accomplish throughout the full width of the stream, because water tends to concentrate in a narrow area.

A series of earthen or concrete dams can be constructed to pool the upstream water to control water flow and ensure soil saturation above each dam. The top of each downstream dam should be at least as high as the bottom of the upstream dam to ensure complete water saturation of the soil.

3.4 CANALS

As fresh water becomes an increasingly more valuable commodity, the

performance of water conveyance canals is being more heavily scrutinized. Existing canals are being rehabilitated to minimize infiltration losses, and new canals are being constructed with careful consideration of their hydraulic performance. The information in this section also applies to the lining of roadside drainage swales, which is becoming an increasingly popular means to limit infiltration of potential environmental contaminants such as oil, lead, and other pollutants that may be released in a spill event.

The design of a lining system for a canal must address the challenges of steep sideslopes, rapid water movement, and time limitations imposed by downstream water users. This section of the design guide discusses these challenges and offers some solutions based on the use of BENTOMAT CL.

3.4.1 SLOPE STABILITY

Trapezoidal water supply canals usually possess steeply sloping side walls which are problematic when synthetic and natural materials are layered together. Additionally, the surficial water velocity in the canal encourages erosion and scouring of cover materials placed on the side slopes. The canal liner must therefore support its protective cover and prevent it from being washed downstream.

When space permits, the easiest and most economical solution to the stability problem is to limit the steepness of the side slopes to 3H:1V. However, this may not prove possible in many cases, especially with rehabilitation projects. With a restrictive geometry, the stability method of Appendix C can be used to determine how long and steep the slope can be under a given cover system configuration. From Table 2-4, it can be seen that the maximum slope length at a 2H:1V angle is 17 feet (5.2 m). From this information and knowledge of the gradient of the canal, it is possible to calculate its carrying capacity. This will help the designer determine the geometry needed to convey the water within whatever space limitations exist.

The side slopes of a canal may not be stable enough to support a layer of stone with an adequate factor of safety to protect against sliding of the cover layer or scouring during peak flows. In such cases, 3–4 inches (75–100 mm) of concrete should be applied directly to the surface of the geotextile side of BENTOMAT CL. When concrete is poured or sprayed over the liner, the exposed needle punched fibers on the surface of the liner embed into the first few millimeters of the concrete, creating a strong mechanical bond.

When the concrete cures, BENTOMAT CL is intimately bonded to it and can be removed only with great difficulty. The rigidity of the concrete provides a strong “passive wedge” that improves stability, and the bond by BENTOMAT CL prevents the possibility that the concrete will crack and delaminate from the liner over the long term. The concrete and BENTOMAT CL liner system should be considered as an option for all water supply canals with side slopes steeper than 3H:1V.

3.5.1 POND SHAPE AND GEOMETRY

It is generally desired for the shape of the pond to have a “natural” ap-

pearance, free of unusually sharp corners or angles. Gradual slopes, curves, and corner transitions always facilitate easier liner installation. On the other hand, sharp corners and angles will complicate the installation process with more frequent cuts, seams, and detail seals. There is a greater chance of leakage problems when the geometry of the pond is too complex.

3.5.2 THE POND FOUNDATION

Subgrade preparation and compaction in accordance with CETCO published specifications is the single most important earthwork aspect in pond design and construction. A smooth, unyielding subgrade provides the proper foundation to build a successful liner system. The designer should take special care to specify that the subgrade soils are capable of being compacted to the extent necessary to deploy the liner on an unyielding surface.

The pond designer should be aware of the seasonal high and low water tables relative to the minimum and maximum water levels expected in the pond. This relates to the potential for hydrostatic uplift. If the water table rises above the water level in the pond, a buoyant force is created. In some cases, the buoyant force could exceed the weight of the soil cover, thus causing uplift of the liner. This could lead to failure of the liner system.

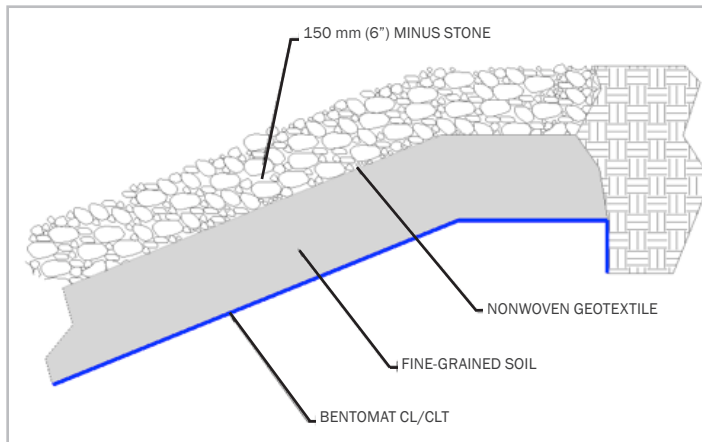

Figure 3-3. Shoreline armor system for long-term protection of liner and cover.

There are two remedies to this potential problem. First, an excess layer of cover soil may be placed on the liner system to counteract the buoyant force. Because the submerged weight of cover soil is approximately equal to the unit buoyant force of water, a general rule of thumb would be to add one foot (300 mm) of cover for every one foot of difference between the two water levels. A second, simpler remedy to prevent uplift is to never allow the water level in the pond to decrease below the seasonal high water level. While hydrostatic uplift is definitely a situation to avoid, it should not be difficult to maintain the water level difference necessary to avoid the situation altogether. Any activities requiring removal of the water should be undertaken only after it is confirmed that the groundwater level is lower than the lowest elevation of the liner system.

3.5.3 THE POND PERIMETER

The pond should have a relatively flat “bench” or very gradually sloping perimeter extending inward at least 5 feet (1.5 m) before a transition to a steeper slope. Not only does the bench allow access by wildlife and humans, it serves as a safety device by providing organisms a chance to exit the pond before encountering deep water. A well-designed bench also allows for rip rap (large stone) to be placed for protection against wave action and scouring.

Pond perimeters constructed only with a layer of cover soil are not likely to provide long-term protection of the liner. A hard armor system is recommended as shown in Figure 3-3. This cover system should be installed from the low water level all the way to the top of the pond slope. In addition to erosion/scouring protection, the stone acts as a capillary break. In arid climates, evaporative forces are strong enough to pull water into fine-grained perimeter soils, thereby increasing the evaporation area beyond the actual water area. If a stone armor system extends to shoreline as shown in Figure 3-3, this capillary action is prevented and evaporation reduced.

In some cases, it is necessary to join the liner to a concrete or stone retaining wall. The objective in this case is to ensure that the liner provides continuous protection from behind the wall and into the pond. A tie-in detail is provided in Figure 3-4. When terminating the liner into existing concrete structures, the detailing should be performed in accordance with Figure 4-9.

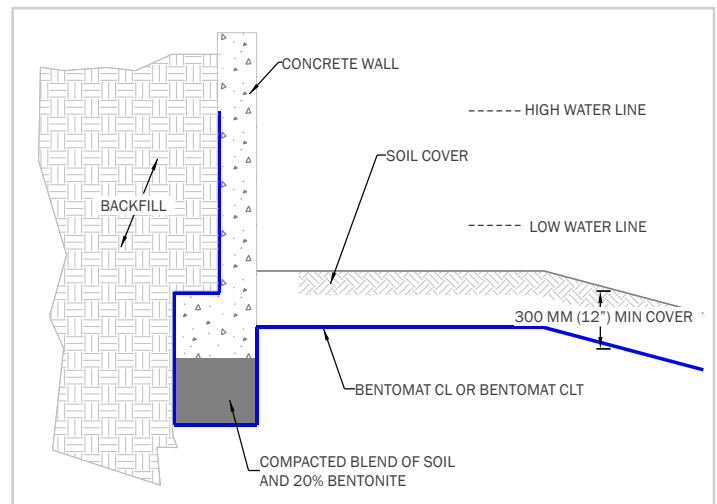

Figure 3-4. Perimeter retaining wall detail.

3.5.4 BOAT RAMPS

The vehicular loading on a boat ramp must not exceed the shear strength of the liner system. The ramp design procedure provided in Appendix D addresses this issue in greater detail.

3.5.5 VEGETATION

Depending on the design, it may be desired to establish vegetation at the perimeter of the pond and/or into the water line. In these cases, the

BENTOMAT® CL and CLT GCLs

depth of cover in the vegetative zone must be increased to a minimum of 2 feet (600 mm) to minimize the potential for root penetration into the liner. In any case, woody vegetation with persistent and deep root penetration should not be established in the pond. Over time, these roots may penetrate through the liner and its overlaps, contributing to increased leakage rates.

3.5.6 ROCK STRUCTURES

Rock structures are often used to enhance the natural beauty and fish habitat of a decorative pond. However, large boulders should never be placed directly on top of the liner. Not only is it likely that the liner will become torn or punctured during placement, but it's equally likely that the boulder will compress and deform the subgrade soils which will further stress the liner. Two design and installation guidelines apply when working with boulders. First, when the boulders exceed 3 feet (1 m) in diameter, it is recommended that the boulder be seated in the subgrade, with the liner cut around and sealed to the boulder. When the boulder is smaller than 1 m, it can be placed on the liner system, but only after two layers of reinforcing/cushioning geotextile are placed on the liner to protect it from damage. In this case, it should be ensured that the subgrade soils are strong enough to support the boulder without deformation. If this is not possible, geogrids or other reinforcement techniques should be used to improve the load distribution capability of the soil in the area where the boulders will be placed.

SECTION 4 LINER INSTALLATION

As discussed in Section 1, a successful pond lining project requires both a good design and a good installation. Fortunately, the forgiving nature of CETCO liner products and the active swelling and sealing properties of bentonite make it relatively easy to successfully install the liner. CETCO Geosynthetic Clay Liner (GCL) Installation Guide (TR-402) is the primary reference on installation, but this manual provides additional details for pond projects.

4.1 EQUIPMENT

CETCO BENTOMAT CL liner is heavy. The installing contractor must have the proper equipment to offload, transport, and deploy the liner. Us-

ing improper or inadequately sized equipment can cause delays, safety hazards, and damage to the liner material. Therefore, detailed equipment requirements are provided to ensure these problems are avoided. The liner is delivered in rolls weighing 2,700–2,950 lbs (1,227–1,340 kg). A strong core pipe is required to support the rolls as indicated in Table 4-1. The core pipe must not deflect more than 3 inches (75 mm) as measured from end to midpoint when a full roll is lifted.

Lifting chains or appropriately rated straps should be used in combination with a spreader bar made from an I-beam or solid steel pipe, as shown in Figure 4-1. The spreader bar ensures that lifting chains or straps do not chafe against the ends of the roll, allowing it to rotate freely during installation. Spreader bar and core pipe kits are available through CETCO.



Figure 4-1. Deploying of the liner using core pipe and spreader bar.

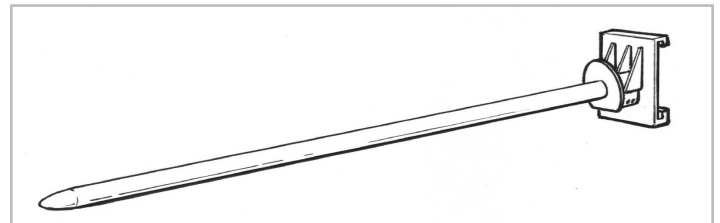

Figure 4-2. Typical stinger used for handling liner material. The dimensions of the mounting plate are specific to the forklift used.

PRODUCT	ROLL SIZE, L X DIAM. FT. (M) X IN. (MM)	TYPICAL ROLL WT., LBS. (KG)	CORE PIPE LENGTH X DIAM., FT. X. IN. (M X MM)	MINIMUM CORE PIPE STRENGTH*
BENTOMAT CL	16' x 25" (4.9 x 635)	2,750 (1,250)	20 x 3.5 O.D. (6.1 x 88)	XXH
BENTOMAT 600CL	16' x 25" (4.9 x 635)	2,700 (1,227)	20 x 3.5 O.D. (6.1 x 88)	XXH
BENTOMAT CLT	16' x 26" (4.9 x 660)	2,950 (1340)	20 x 3.5 O.D. (6.1 x 88)	XXH

Table 4-1. Core pipe requirements for safely handling CETCO liners.

*This is the strongest pipe grade available; XXH is "extra-extra heavy."

A front end-loader, backhoe, excavator, or other equipment can be utilized with the spreader bar and core pipe. Alternatively, a forklift with a “stinger” attachment may be used for on-site handling and, in certain cases, installation. A forklift without a stinger attachment must not be used to lift or handle the rolls. A stinger attachment as shown in Figure 4-2 can be specially fabricated to fit various forklift models. Additional equipment needed for installation of CETCO pond liners includes:

- Utility knife and spare blades (for cutting the liner)
- Bentonite-water paste (for sealing around structures and details) and/or granular bentonite (for seams and for sealing around structures and details)
- Waterproof tarpaulins (for temporary cover on installed material as well as for stockpiled rolls)
- Flat-bladed vise grips (for gripping and positioning the liner panels by hand)

4.2 SHIPPING UNLOADING AND STORAGE

4.2.1 SHIPPING

To account for waste and overlaps, the area of liner ordered should exceed the lined area by approximately 15% (rounded up to the nearest roll quantity) depending on the relative complexity of the site. Two bags of accessory bentonite per roll of liner ordered is generally sufficient for overlaps, details, and penetrations. Upon receipt of the liner, all lot and roll numbers should be recorded and compared to the packing list. Each roll of liner should also be visually inspected during unloading to determine if any packaging has been damaged. Damage, whether obvious or suspected, should be recorded and marked. Major damage suspected to have occurred during transit should be reported immediately to the carrier and to CETCO. The nature of the damage should also be indicated on the bill of lading with the specific lot and roll numbers.

4.2.2 UNLOADING

The party directly responsible for unloading the liner should refer to this manual prior to shipment to ensure that they have the proper unloading and handling equipment. CETCO GCLs can be delivered in either flatbed trucks or vans. To unload the rolls from the flatbed using a core pipe and

spreader bar, first insert the core pipe through the core tube. Secure the lifting chains or straps to each end of the core pipe and to the spreader bar mounted on the lifting equipment. Lift the roll straight up and make sure its weight is evenly distributed so that it does not tilt or sway when lifted. NEVER PUSH ROLLS OFF THE SIDE OF THE FLATBED TRUCK.

In some cases, rolls will be stacked in three pyramids on flatbed trucks. If slings are not used, unloading can be accomplished with a stinger bar and extendible boom fork lift such as a Caterpillar TH83 or equivalent with 8,000 lbs (45 kN) lifting capacity. Spreader bars will not work in this situation because of the limited space between the ends of the rolls. To unload liner rolls oriented in this way, guide the stinger bar as far as possible through the core tube before lifting the roll from the truck.

Rolls should be stored at the job site away from high-traffic areas but sufficiently close to the active work area to minimize handling. The designated storage area should be flat, dry and stable. Moisture protection of the liner is provided by its existing packaging; however, an additional tarpaulin or plastic sheet should be placed over the rolls for additional protection of the liner. Rolls can be stored indefinitely if these procedures are implemented. Rolls should be stored with the directional arrows oriented in the same direction to save materials handling time during installation.

The material should be stacked in a manner that prevents them from sliding or rolling. This can be accomplished by frequent chocking of the bottom layer of rolls. Rolls should be stacked no higher than the height at which they can be safely handled by laborers (typically no higher than four layers).

4.3 SUBGRADE PREPARATION

The subgrade is the foundation for the liner, and its importance cannot be overemphasized. Proper subgrade preparation will greatly improve the chances for a successful outcome. Conversely, deploying liner over a poor foundation can easily lead to trouble. Every attempt should be

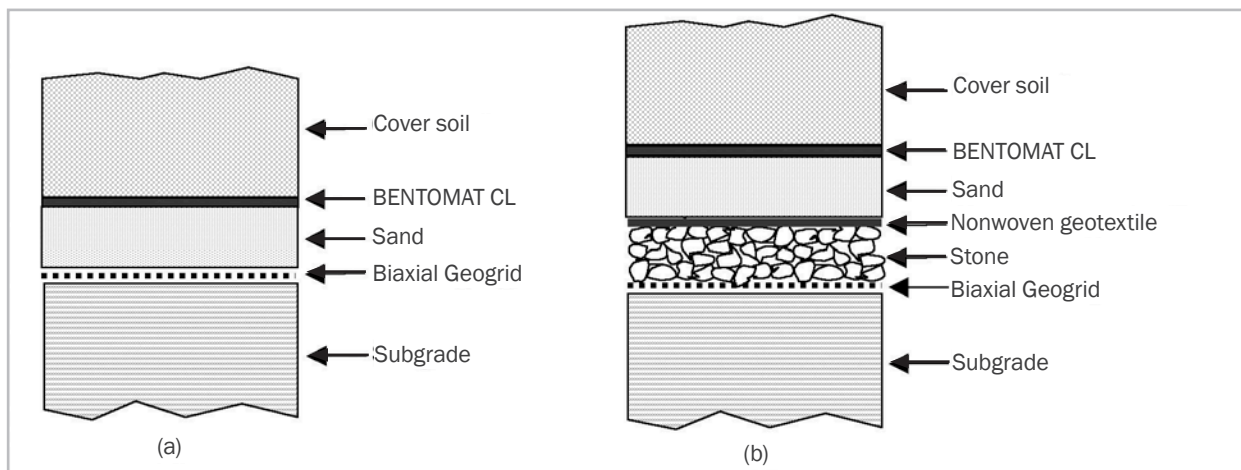

Figure 4-3. Use of geogrid and geotextile to reinforce unstable subgrade soils.

BENTOMAT® CL and CLT GCLs

made to adhere to the following subgrade preparation procedures.

Subgrade surfaces consisting of coarse granular soils or gravel may not be acceptable due to their large void fraction puncture potential. The finished surface should be firm and unyielding, without abrupt elevation changes, voids, cracks, ice, or standing water. Additionally, the subgrade surface must be smooth and free of vegetation, sharp-edged rocks, stones, sticks, construction debris, and other foreign matter that could contact the liner. The subgrade should be rolled with a smooth-drum compactor to remove any wheel ruts, footprints, or other abrupt grade changes. All protrusions extending more than 0.5 inch (12 mm) from the subgrade surface shall be manually removed, crushed, or pushed into and flush with the surface. The liner may be installed on a frozen subgrade, but the subgrade soil in the unfrozen state should meet the above requirements.

4.3.1 UNSTABLE SUBGRADE CONDITIONS

Soft subgrade soils are often present in pond construction. It is essential that the subgrade be made firm and unyielding as described above, but in many cases the soils cannot be compacted properly. Several techniques are available to compensate for poor subgrade conditions. In moderately unstable subgrade conditions, the contractor may wish to install the liner during winter months when the subgrade is frozen. If this solution is considered, it is important to prepare the subgrade to accept the liner prior to freezing.

Another means to improve subgrade soil stability is to eliminate pore water and consolidate the subgrade soils. In this method, a biaxial geogrid is placed directly on the unstable soil. A layer of sand or similarly porous soil is placed over the geogrids. The geogrid reinforces the unstable soils and distributes the loading of equipment and the overlying drainage media. Water collected in the drainage layer can be directed to a sump. The liner can then be deployed and covered, which will cause further consolidation and stabilization of the subsoils (Figure 4-3a). The overlap should be increased to 2 feet (600 mm) in these situations.

Subgrades can also be stabilized by mixing clay or other more cohesive soil into the surface. For compatibility purposes, lime should not be used for subgrade stabilization unless the membrane side of the product is installed facing down.

If the subgrade soils are still not able to bear the load of the liner and its cover system, the design can be modified to include a higher strength biaxial geogrid and/or the incorporation of stone as shown in Figure 4-3b. Reputable manufacturers of geosynthetic reinforcement products offer design guides that assist in the identification of suitable products for this application.

4.4 LINER DEPLOYMENT

4.4.1 BASIC PLACEMENT GUIDELINES

Equipment which could damage the liner should not be allowed to travel directly on it. An ATV can be driven directly on the GCL provided that no sudden stops, starts, or turns are made. Acceptable installation may be accomplished with a liner that is unrolled in front of backwards mov-

ing equipment. If the installation equipment causes rutting of the subgrade, the subgrade must be restored to its originally accepted condition before placement continues.

If sufficient access is available, the liner may be deployed by suspend-

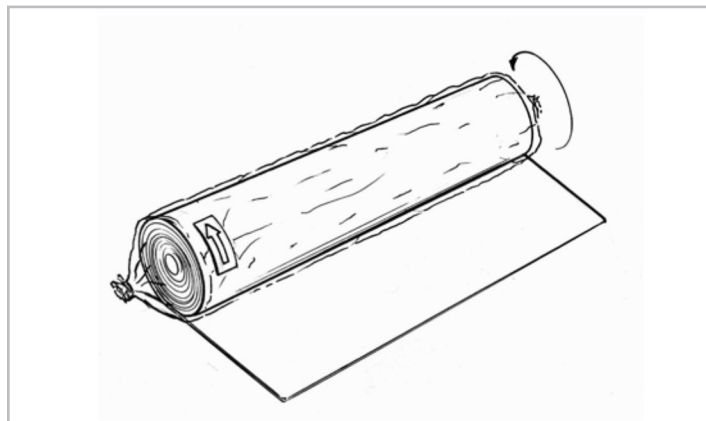

Figure 4-4: The direction of unrolling is shown by the arrow on the plastic sleeve.

ing the roll at the top of the slope and by pulling the material off the roll and down the slope. Rolls should never be released on the slope and allowed to unroll freely by gravity. Care must be taken to minimize the extent to which the liner is dragged across the subgrade in order to avoid damage to its membrane surface. In cases where there is no other choice except to drag the liner, a thin smooth plastic membrane or “slip sheet” should be used as a temporary subgrade covering to reduce friction damage during placement. The slip sheet should be removed after the liner is deployed.

The liner should be placed so that seams are parallel to the direction of the slope. End-of-roll seams should be located at least 3 ft (1m) from the toe and/or crest of all slopes steeper than 4H:1V. End-of-roll overlapped seams on slopes should be used only if the liner is not expected to be in tension (see Section 2.2). All panels should lie flat on the underlying surface, with no wrinkles or folds, especially at the exposed edges of the panels.

The liner should not be installed in standing water or during rainy weather. Only as much material should be deployed as can be covered by the end of the working day with soil or a temporary waterproof tarpaulin. The liner should not be left uncovered overnight. If it is hydrated before cover is applied, the liner may become damaged. CETCO offers specific guidance on this situation as provided in CETCO’s TR-312.

4.4.2 PLACEMENT STRATEGIES

Placement of the liner for most ponds should begin on the side slopes. The main reason for this recommendation is to prevent rainfall from eroding and scouring the prepared subgrade. Another benefit is that the unlined bottom area can be used to stockpile and push cover soil onto the lined slopes. A roadway or ramp area should be left unlined to allow ongoing vehicle access into and out of the pond. Depending on the size of the pond, separate inbound and outbound access ramps may be

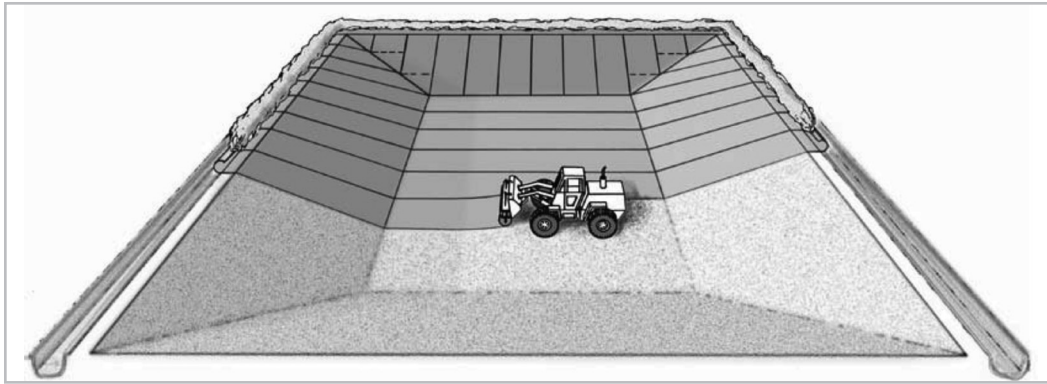

Figure 4-5. In corners, the liner should be maintained perpendicular to the slope and trimmed into a herringbone pattern.

used. The liner should be deployed on the entire slope extending into the bottom area by approximately 6 feet (2 m).

For corners, the liner should be placed in a “herringbone” pattern as shown in Figure 4-5. It is important that the liner remain perpendicular to the slope. Panels from both sides of the corner will converge at the corner line. The triangular end of the overlapping panel should be cut along the corner line, while the end of the underlying panel extends beyond the corner line as shown in Fig. 4-5.

After the slopes have been lined, the bottom area should be lined starting with the location farthest from the access ramp(s). Cover soils may be staged at other locations in the bottom area if space is available. The liner materials placed on the floor of the pond should be lapped under the “tails” of the liner previously deployed on the slopes, creating a shingling effect to convey rainfall off the liner system. Liner placement on the bottom areas should continue back toward the access road/ramp system, leaving it to be lined last. Covering of the slope and bottom areas should be completed before the ramp is lined.

4.5 ANCHORAGE

The liner requires anchorage at the top of the side slopes. Anchorage is most commonly accomplished using an anchor trench as discussed in Section 2.2.7. The front edge of the trench should be rounded to eliminate any sharp corners that could cause excessive stress on the liner. Loose soil should be removed or compacted into the floor of the trench. Soil backfill should be placed in the trench to provide resistance against pullout. The backfill material must be compacted using a hand tamper or a small walk-behind compactor. The size and shape of the trench should be in accordance with Figure 4-6.

The liner should be placed in the anchor trench such that it covers the entire trench floor but does not extend up the rear trench wall (to prevent water retention in the trench). For gentle slopes of 4H:1V or less, sufficient anchorage may alternately be obtained by extending the end of the liner roll back from the crest of the slope, and placing cover soil. The length of this “runout” anchor is project-specific but is usually sufficient at 5 feet (1.5 m).

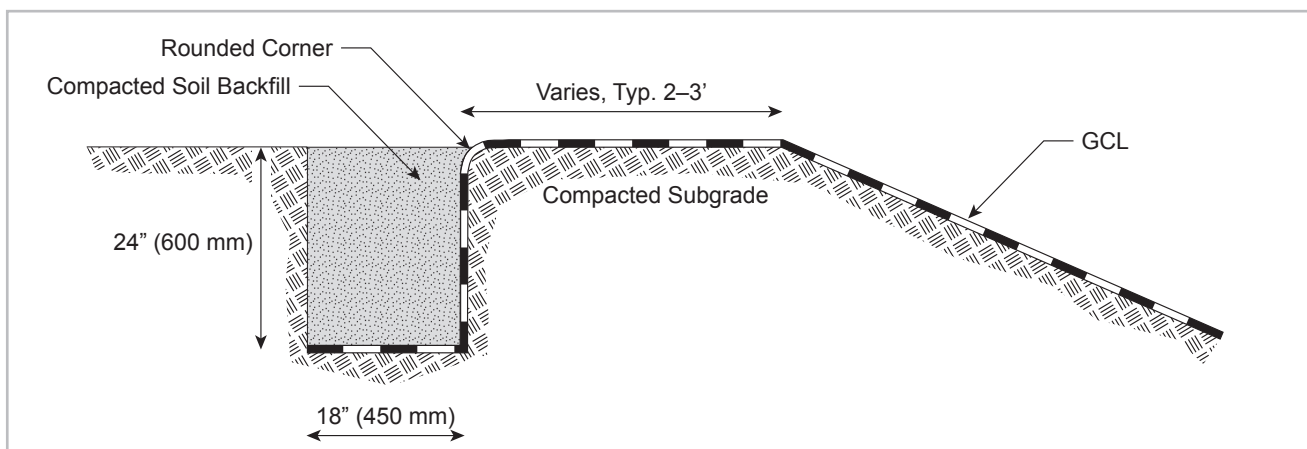

Figure 4-6. Typical anchor trench at top of slope.

BENTOMAT® CL and CLT GCLs

4.6 SEAMING

Seams are constructed by overlapping their adjacent edges. Each longitudinal edge of the rolls is marked at the factory with a “lap line” at 12 inches (300 mm) from the edge of the panel and a “match line” at 15 inches (375 mm) from the edge of the panel. The objective in seaming these edges is to place the overlying panel such that the lap line is completely covered (ensuring that a minimum required overlap is achieved) while allowing the match line to remain visible (ensuring that liner material is not wasted). Greater panel overlaps may be required in high-head applications or in yielding subgrade soils.

Before completing the seam, care should be taken to ensure that the overlap is not contaminated with loose soil or other debris. After the panels have been placed, the overlap should then be turned back so that supplemental bentonite (VOLCLAY® CG-50 provided by CETCO) can be distributed within the overlap zone at a rate of one quarter pound per linear foot (0.4 kg/m). The location of this “bead” or “fillet” of bentonite should be at 6 inches (150 mm) inward from the edge of the bottom panel.

End-of-panel overlapped seams should be similarly constructed, except the overlap dimension is increased to 24 inches (600 mm). End-of-panel seams on slopes are permissible, but only if the slope steepness is 4H:1V or less. Overlaps should be shingled such that water flows across, and not into, the overlap zone. This is especially important in any application where water will be actively flowing, such as streams and canals.

4.7 SEALING AROUND PENETRATIONS AND STRUCTURES

Cutting the liner should be performed using a sharp utility knife. Frequent blade changes are recommended to avoid irregular tearing of the geotextile components of the liner during the cutting process. The liner should be sealed around penetrations and structures embedded in the subgrade in accordance with Figures 4-7 and 4-8. Granular bentonite or a bentonite mastic shall be used liberally (approx. 2 lb/lin ft or 3 kg/m) to seal the liner to these structures.

When the liner is placed over a horizontal pipe penetration, a notch should be excavated into the subgrade around the penetration (Figure 4-7a). The notch should then be backfilled with bentonite paste. A secondary liner collar should be placed around the penetration as shown in Figure 4-7b. It is helpful to first trace an outline of the penetration on the liner and then cut a starburst pattern in the collar to improve its fit around the penetration. Bentonite paste should be applied between the primary BENTOMAT CL layer and the secondary liner collar.

As discussed previously, vertical penetrations are not generally recommended because of their tendency to induce leak problems. However, if a vertical penetration is needed, it should be prepared by notching into the subgrade as shown in Figure 4-8. A secondary collar can be placed as shown in Figure 4-7.

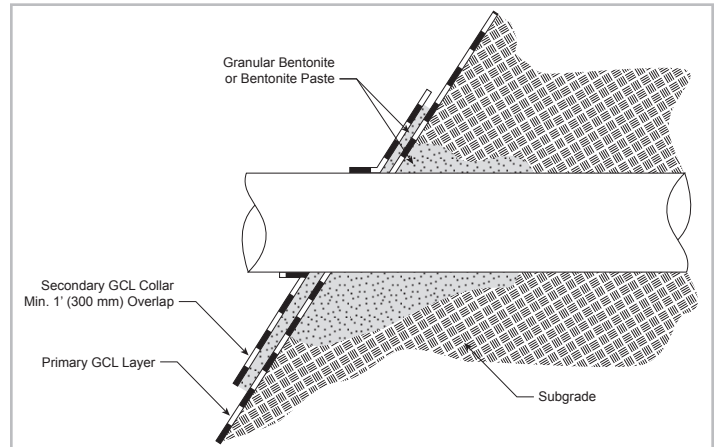

4.7 (a)

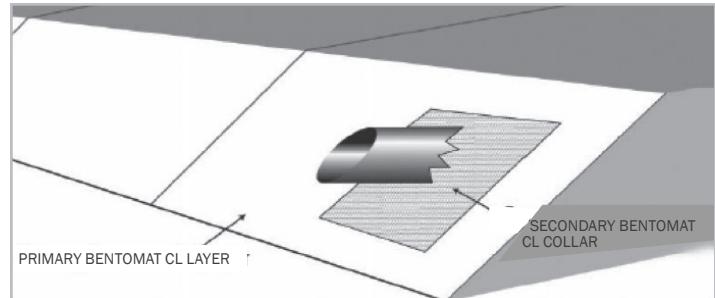

4.7 (b)

Figure 4-7. Horizontal pipe penetrations are potential leakage zones and must be detailed properly. These diagrams show the proper installation procedures.

When the liner is terminated at a structure or wall that is embedded into the subgrade on the floor of the containment area, the subgrade should be notched shown in Figure 4-9. The notch is filled with granular bentonite, and the liner should be placed over the notch and up against the structure. The connection to the structure can be accomplished by placement of soil or stone backfill in this area. When structures or walls are on or at the top of a slope, additional detailing may be required as shown in Figure 3-4.

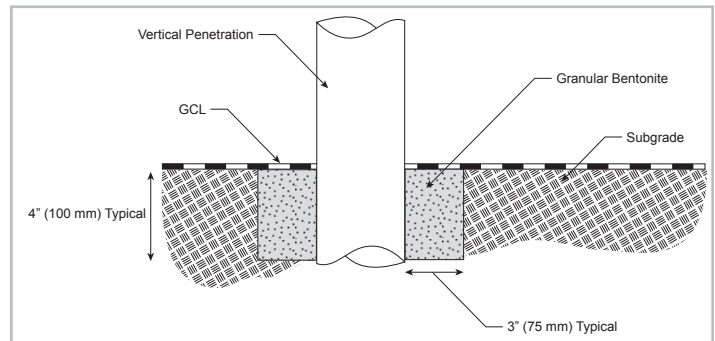

Figure 4-8. Detailing around a vertical penetration.

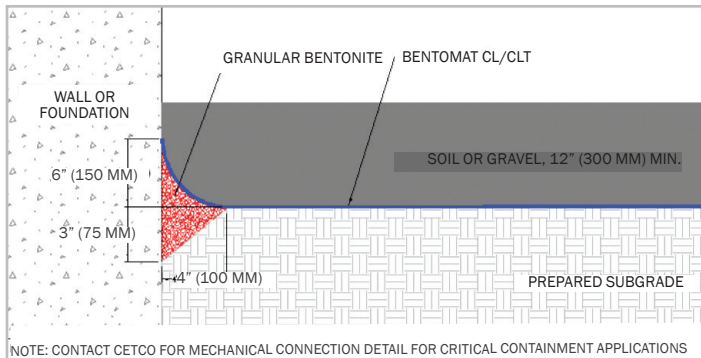

Figure 4-9. Termination of the liner at a structure embedded in the subgrade.

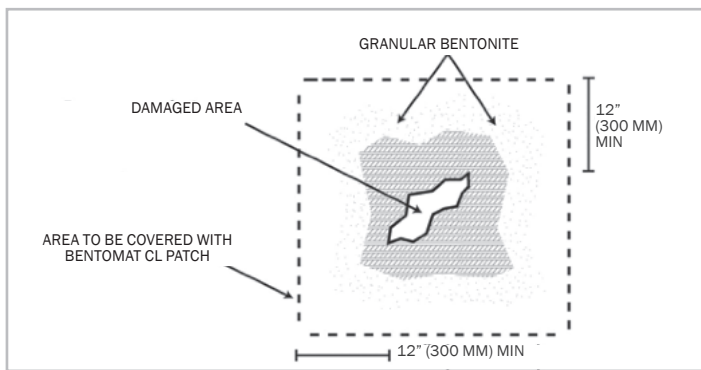

Figure 4-10. Damage repair through patching.

4.8 DAMAGE REPAIR

If the liner is damaged (torn, punctured, etc.) during installation, it may be possible to repair it by placing a patch to fit over the damaged area (Figure 4-10). The patch should be cut to size such that a minimum overlap of 12 inches (300 mm) is achieved around all parts of the damaged area. Granular bentonite or bentonite mastic should be applied around the damaged area prior to placement of the patch. It may be necessary to use an adhesive such as wood glue or liquid nails to affix the patch in place so that it is not displaced during cover placement. Smaller patches also may be tucked under the damaged area to prevent patch movement.

4.9 COVERING THE LINER

All pond projects require that the liner be covered with a layer of soil and/or stone. The cover serves several vital functions in the pond system. Specifically, it:

- Confines the liner and prevents free swell of the bentonite, allowing the bentonite layer to function effectively as a water barrier and to prevent flow within the overlapped seams.
- Protects the liner from damage by humans, animals, plants. Also protects against damage by ultraviolet light, erosional forces, and extreme weather conditions.
- Beautifies the pond by giving the liner system a natural appearance.

In general, the deeper or thicker the cover layer, the better the long-term hydraulic performance of the liner system. But it is seldom cost-effective or practical to install thick cover soil layers.

4.9.1 COVER THICKNESS

The minimum recommended thickness of cover soil on the liner is 12 inches or 300 mm. This recommendation is based on the following:

1. The confining stress provided by 300 mm of soil is adequate to keep the overlaps closed and to prevent lateral seam leakage. The flux test data provided in Appendix A verifies the adequacy of this thickness of cover soil.
2. A soil layer of 300 mm is sufficient to distribute loads from typical earthmoving equipment which would otherwise damage the liner. Fox, et. al. (1998) performed a comprehensive study examining many different cover materials, thicknesses, and placement methods. The most important result of the study was that, when adequate cover thickness was in place, equipment had little influence on the physical integrity and performance of the liner.
3. It is very difficult to install thinner layers of soil on a liner without damaging it.

Some projects may require more cover material when disruptive forces such as scouring or wave action are considered. In these projects, up to 2 feet (600 mm) of cover may be necessary. Fine-grained soil would be placed directly on BENTOMAT CL, followed by a cushioning geotextile and a layer of angular stone (Figure 3-3).

4.9.2 COVER PLACEMENT

Equipment operators should understand that the liner must be protected. They must not allow soil or stone to fall a long distance when a loader bucket is emptied. They must not drive directly on the liner unless it is proven that the vehicle in question can do so without damaging the liner. As a general rule, tracked equipment should not be permitted to come in direct contact with the liner. Rubber-tired equipment is usually acceptable, assuming a firm foundation has been established.

Cover placement activities typically involve one piece of equipment dumping the cover in a pile near the site, and one piece of equipment spreading the cover. These activities should be coordinated such that the placement effort does not outpace the covering effort. At the end of the working day, the exposed liner should be completely covered with the exception of a leading edge where the next day's liner installation will overlap. This will ensure that the liner will not be accidentally damaged and displaced by equipment or other forces. The leading edge of the liner should be protected from damage by rolling it under itself. If the leading edge is at the base of a slope to be covered, plywood sheets will afford protection while allowing access by cover placement equipment.

Cover for the liner should be placed at the bottom of the excavation so that it can be pushed upslope. Although it may be more convenient to dump cover soil at the top of the pond and push it downslope, enormous tensile stresses can occur on the liner from the thick cover layer resting (without a toe buttress) on the slope and from the weight of the equipment pushing on it. By staging liner deployment such that one or

BENTOMAT® CL and CLT GCLs

more access ramps are left unlined until the end of the project, the cover soil can be efficiently delivered to the bottom of the pond without damaging the liner system or causing undue expense. It is important to include this provision in the project specifications so that contractors can plan for this covering methodology.

4.9.3 COVER TYPE

The cover on the liner must not contain large and/or angular stones capable of damaging the liner. Cover soils should have a particle size ranging from fine to < 1 inch (25 mm) in diameter, unless a cushioning geotextile is placed on the liner. Common sense should play a primary role in assessing the suitability of the cover. If there are many sharp stones visible in the proposed cover soil, then it probably is not an appropriate material. Stone may be used as cover only if it is a washed gravel or similarly graded materials that does not possess sharp edges. The cover should also be compactable. Non-cohesive soil (pure sand) and fat clay may not be suitable if the soil cannot be placed and trafficked by equipment without rutting. Therefore, dry soils should be wetted to improve workability and compaction, and especially wet soils may require additional time to dry out before being placed over the GCL.

4.10 COVER SOIL/STONE STABILITY

The liquid containment system must be designed to provide long-term performance under all expected operating conditions. Fundamental to this objective is the integrity and stability of the cover soil. BENTOMAT CL needs the confinement provided by cover soil so that the overlaps will self-seal and the bentonite is not permitted to reach free-swell conditions. Failure to provide and maintain these conditions could result in failure of the liner system. In other words, when confinement is provided through an initial application of cover, that cover must not be compromised.

4.10.1 EROSION PREVENTION

Erosion occurs as a result of a driving force of rapidly moving water which overcomes the gravitational and cohesive resisting forces of a cover soil. In pond applications, rapidly moving water can be caused by drainage of a sloped area or by shoreline wave impact. Erosion can be prevented in two ways. The first and most cost-effective preventative strategy is to utilize sensible design practices:

- Use moderate slopes. Water velocity can be reduced if grades are as gentle as possible.
- Use erosion-control materials. Mulch and hay bales represent the crudest form of erosion control products, but there are a variety of cost-effective natural fiber and synthetic products that offer superior performance over a longer term.
- Limit slope lengths. A long slope will allow water velocity to reach critical levels. Shorter slopes and mid-slope diversion swales will alleviate this problem.
- Use energy diffusion devices. Inflow and outflow areas within a pond may be subjected to scouring by rapidly moving water. Water velocities can be reduced in these areas by erecting baffles, deploying large stones, or installing other energy-diffusion structures.

4.10.2 ALTERNATIVE COVER MATERIALS

Interior sideslopes of ponds may be exposed to wave action, animal contact, fluctuating water levels, and equipment loadings such as mowers or other vehicles. All of these elements can contribute to erosion, and for this reason, alternative cover materials may be required. The use of concrete, rip rap, or protective geotextiles are all valid means by which slopes may be preserved. More detail on these techniques is provided in Section 3.

4.11 WEATHER

The bentonite component of BENTOMAT CL will absorb water in wet conditions. As a result, the liner becomes heavier and more difficult to move. It also becomes softer and more susceptible to damage by installation equipment or by stones in the cover soil. For these reasons, extra care should be taken when the product is installed in wet weather. Ideally, BENTOMAT CL should be installed and covered with at least 1 foot of cover soil as soon as possible and before a rain event. In most instances, early hydration of BENTOMAT CL products is not a major concern. CETCO's TR-312 provides a checklist (summarized in Appendix F) to reference to evaluate premature hydration on a site-specific basis. BENTOMAT CL is not affected by warm or cold temperatures and there are no restrictions or limitations relating to ambient temperatures, again provided that the subgrade can be properly prepared.

Wind uplift during installation is possible, although rare, with BENTOMAT CL. Very high winds may be able to displace the liner, so some form of ballast should be used if these conditions are present. Sandbags are commonly used for this purpose. Due to the self-weight of BENTOMAT CL, wind uplift is not encountered frequently.

4.12 CONSTRUCTION QUALITY ASSURANCE (CQA)

Construction Quality Assurance refers to a set of procedures performed during the project to ensure that the liner is placed and covered in accordance with the instructions provided herein. In critical projects, a CQA plan is developed and implemented by a third party who may provide inspections, tests, and measurements to confirm proper installation. In most pond projects, this added level of oversight may not be necessary or desirable. However, some CQA concepts are useful to employ even in the absence of a dedicated CQA plan.

The most important CQA procedures are those which can prevent damage to the liner. Prior to installation, the subgrade should be inspected for soft spots, protrusions, and uneven surfaces (such as ruts). These areas should be repaired before the liner is deployed. Prior to covering, the liner itself should also be inspected to ensure that it has not been damaged, the overlaps are adequate, and that the details and penetrations have been properly constructed. Finally, the covering process should be monitored to ensure that the liner is not damaged by equipment or rocks in the cover soil. Periodic thickness measurements should also be taken. If CQA oversight functions are performed as described above, there is a far greater chance that problems will be prevented. The owner of the pond should make sure that a record of CQA activities and inspections is created as part of the contract documents. CQA services are typically provided by a third-party company.

The purpose of this manual is to illustrate sound design and construction practices needed to ensure long-term performance of the liner system. Ideally, a properly designed and constructed pond liner system will require very little maintenance. But water can be a very destructive force, and so it is worthwhile to discuss the procedures needed to maintain the original condition and function of the liner.

SECTION 5 OPERATION AND MAINTENANCE

5.1 INITIAL FILLING

The pond is most vulnerable to erosion and scouring damage immediately after its construction. Heavy rainfall and over-aggressive filling procedures can wash soil cover off the slopes and even displace the liner altogether. Special care must be taken at this critical time in order to protect the integrity of the completed construction.

Filling of the pond may occur through natural precipitation, run-on, or through adding water. Whatever means are selected to introduce water to the pond, it is essential to eliminate turbulent flow conditions which can scour and erode the cover soil. The less cohesive the cover soil, the more prone it will be to washout. Heavy rains immediately after construction are a worst-case scenario because erosion rills and gullies can form, especially on the side slopes. This is another reason why hard armor on the side slopes is beneficial. If such a rain event occurs, eroded soils must be replaced and recompact to a minimum depth of 12 inches (300 mm) and a preferred depth of 18 inches (450 mm). When adding water through a hose, the velocity of the water from the nozzle will cause similar erosion problems. An apron of rock should be placed around the nozzle to dissipate this destructive force. For ponds that will fill by run-on from a stream entering the pond, this entry area should be protected with rock as well. As a general rule, the velocity of any water entering the pond should be kept as low as possible until the pond is filled to its design depth.

Prior to filling the pond with water, all piping servicing the pond should be pressure-tested for leaks at joints and valves. This is a critical step in eliminating a potential source of water loss that could be incorrectly interpreted as pond leakage at a later time.

5.2 SLUDGE AND SEDIMENT REMOVAL

As discussed in Section 3, in certain applications such as sedimentation basins and sludge lagoons, it may be necessary to periodically remove the water and excavate the accumulated solids on the bottom of the lagoon. In such cases, the removal should be performed using methods and equipment that will not damage the liner.

There is little doubt that concrete provides the best surface for periodic removal operations. It protects the liner, distributes vehicle loads, and ensures that a certain minimum distance will always be maintained between the equipment and surface of the liner. While similar benefits exist with a stone layer, it is more vulnerable to accidental excavation. Equipment loading on the liner system must be evaluated both on flat interior areas of the lagoon as well as slopes. Dedicated ramp areas designed into the lagoon (Appendix D) will help prevent the possibility that heavy vehicle loads will be imposed on other side slopes that are not adequately reinforced.

5.3 PERFORMANCE MONITORING

It is difficult to quantitatively monitor the performance of the liner system. To estimate the liner seepage rate in an existing lagoon, a water balance must be performed which considers sources of inflow and outflow as shown below:

SOURCES OF INFLOW	SOURCES OF OUTFLOW
Streams = S	Liner leakage = L
Precipitation = P	Evaporation = E
Run-on = R	Overflow = O

The change in water level (ΔD) is therefore the difference between the sum of the outflow sources and the sum of the inflow sources. If ΔD is positive, the water level is rising; if ΔD is negative, the water level is dropping. In a situation where the amount of leakage is suspected to be excessive, it is useful to perform a water balance calculation as a means to assess the problem.

To measure water loss, a measuring stick should be placed in the water column, far enough from shore to minimize the effects of wave action. An initial reading should be made at time zero, with subsequent readings made once each day. If water loss is not accurately recordable in one day, then allow several days to elapse before taking the next measurement, and obtain a value for ΔD by dividing the total observed water loss by the number of days in the observation period. If there is precipitation during this time, a rain gage should be used and these values recorded also. With this data, a water balance calculation can be performed to determine whether the liner is performing adequately. Example: A farmer suspects that his BENTOMAT CL-lined 2.5 acre (1 Ha) irrigation pond is leaking excessively. He measures a water level decrease of 0.75 inches (19 mm) over 5 days. During this observation period there was a 1-inch (25 mm) rainfall. The water level has already dropped below the outflow spillway. The pond has no inflow spillway and there has been no run-on. The average temperature during this time was 80° F (26.7° C); the average relative humidity was 58%, and the average wind speed was approximately 8 mph (14 Km/h). Is the liner leakage rate within accepted standards?

BENTOMAT® CL and CLT GCLs

ANSWER:

$$\Delta D = \Sigma \text{Inflow} - \Sigma \text{Outflow}$$

$$\Delta D = (S + P + R) - (L + E + O), \text{ (Equation 5-1) where:}$$

$$\Delta D = -19 \text{ mm/5 days} = -3.8 \text{ mm/day}$$

$$S = 0 \text{ because there is no inflow source}$$

$$P = 25 \text{ mm/5 days} = 5 \text{ mm/day}$$

$$R = 0$$

$$L = \text{liner leakage, the unknown variable}$$

$$E = 6.7 \text{ mm/day as indicated by the evaporation nomograph in Appendix B}$$

$$O = 0 \text{ because the water level is below the outflow pipe}$$

Inserting the variables into Equation 5-1 and solving for the liner leakage rate, we obtain:

$$\Delta D = (S + P + R) - (L + E + O)$$

$$-3.8 = (0 + 5 + 0) - (L + 6.7 + 0)$$

$$-3.8 = 5 - L - 6.7$$

$$L = 3.8 - 1.7 = 2.1 \text{ mm/day}$$

Comparing this value for L to the net leakage of 0.036 mm/day calculated in Section 2.3.7, we can see that the pond is leaking more than would be expected based on the properties of the liner system. However, it is important to note that evaporation, not leakage, is the largest source of water loss in this example. Performing this calculation is useful if for no other reason than to understand this point.

Appendix B, which contains the nomograph used in this example, also contains a map of the United States showing seasonal “pan” evaporation rates. These rates were obtained from averaging seasonal evaporative losses from small pools of water in various parts of the country during the so-called “evaporative season” of May through October. Because pan evaporation tends to overestimate actual evaporation, these rates are multiplied by a correction factor of 0.7. Returning to Example 1, if the pond in question were located in New York City, a seasonal evaporation rate of 40 inches per 6 months or 5.6 mm/day is predicted. The actual pond evaporation would therefore be $5.6 \times 0.7 = 4 \text{ mm/day}$. This is an average rate, and it should be realized that actual rates for smaller time increments can be significantly higher or lower.

5.4 INSPECTIONS

All lined ponds should be inspected on a quarterly basis (at minimum), in addition to after a significant rain or snow event. With respect to the integrity of the liner system, the inspections should include observation of the following:

- Depth and uniformity of cover layers
- Integrity of hard armor system at shoreline
- Presence of deep-rooted vegetation in the cover soil
- Signs of burrowing animals
- Signs of settlement or erosion around weirs, spillways, inlet/outlet pipes
- Current water level in relation to design water level

If the inspection reveals any problems, corrective action should be tak-

en as soon as possible. Especially critical is the need to maintain cover over the liner system. Immediate repairs must be performed if the cover soil/stone is washed away and the liner is exposed. Records should be kept of inspections and any required maintenance.

5.5 ADDRESSING LEAKS

If inspections and water balance calculations reveal that unacceptable leakage is occurring, then the following guidelines may be helpful in identifying the source of the problem. If leaks occur immediately upon the initial filling with water, then it is quite likely that there has been an installation-related flaw in the pond. The steady-state water level may, in fact, indicate the location of the leak. In any case, special attention should be focused on all details and terminations. These areas are the most difficult to construct and are therefore the most likely sources of leakage.

If significant leakage does not occur immediately, but does occur within one month of filling the newly constructed pond, then it is likely that water has worked its way into another construction/installation related flaw. The same areas mentioned above should be carefully inspected and repaired as needed.

Finally, if major leakage occurs in the long-term after many months or years of negligible leakage, it is likely that the problem is attributable to longer-term forces such as burrowing animals, root intrusion, or sub-grade stability problems. Repairs on these problems are site-specific.

REFERENCES

- Alther, G., Evans, J.C., Fang, H.-Y., and K. Witmer, (1985) "Influence of Inorganic Permeants Upon the Permeability of Bentonite," Hydraulic Barriers in Soil and Rock, ASTM STP 874, A.I. Johnson, R.K. Frobels, N.J. Cavalli, C.B. Peterson, Eds., American Society for Testing and Materials, Philadelphia, PA, pp. 64–73.
- Bierwirth, J.E. and Richardson, G.N. (2003) "Surface Impoundment Rehabilitation," Geotechnical Fabrics Report, Vol. 21, No.3, pp. 18–20..
- Farnsworth, Richard K., Edwin S. Thompson, and Eugene L. Peck (1982) After Map 1: May-October Pan Evaporation. In NOAA Technical Report NWS 33, Evaporation Atlas for the Contiguous 48 United States, National Weather Service, NOAA, Washington, D.C., 1982.
- Fox, P.J., Triplett, E.J., Kim, R.H., and J.T. Olsta (1998) "Field Study of Installation Damage for Geosynthetic Clay Liners, Geosynthetics International, Vol. 5, No. 5, pp. 491–520.
- Giroud, J.P., and J.F. Beech (1989) "Stability of Soil Layers on Geosynthetic Lining Systems," Geosynthetics '89, Industrial Fabrics Association International, pp. 35–46.
- Giroud, J.P. and K. Badu-Tweneboah, (1990) "Rate of Leakage Through a Composite Liner Due to Geomembrane Defects, Geotextiles and Geomembranes, Elsevier Science Publishers, Ltd., England.
- Giroud, J.P., (1997) "Equations for Calculating the Rate of Liquid Migration Through Composite Liners Due to Geomembrane Defects," Geosynthetics International, Volume 4, Nos. 3–4, pp. 335–348.
- Great Lakes—Upper Mississippi River Board of State and Provincial Public Health and Environmental Managers (1997), "Recommended Standards for Wastewater Facilities," Health Research, Inc., Albany, NY, Ch. 90.
- Koerner, R. (1994) Designing With Geosynthetics, Third Ed., Prentice Hall, Upper Saddle River, NJ, pp. 486–492. Koerner, R.M., (1996) "Current Status of the Cincinnati GCL Test Plots," Proceedings of the 10th GRI Conference, Field Performance of Geosynthetic Related Systems, December 10–11, 1996, Philadelphia, PA, pp. 147–175. Matson, Tim (1991) Earth Ponds, Countryman Press, Woodstock, Vermont.
- Koerner, R. and Soong, T.-Y. (2005) "Analysis and design of veneer cover soils," Conference proceedings, Geosynthetics International, 2005, 12, No. 1.
- McKelvey, J.A, and Deutsch, W.L. (1991) "The Effect of Equipment Loading and Tapered Cover Soil Layers on Geosynthetic Lined Landfill Slopes," Conference Proceedings, Fourteenth Annual Madison Waste Conference, University of Wisconsin-Madison, September 25–26, 1991.
- Richardson, G.N. (2002) "Surface Impoundment Design Goals," Geotechnical Fabrics Report, Vol. 20, No.3, pp. 16–17. Richardson, G.N. (2000) "Non-Environmental Surface (Liquid) Impoundments," Geotechnical Fabrics Report, Vol. 20, No.3, pp. 26–29.
- SGI (2001) Final Report, Large-Scale Flow Testing, Seamed and Unseamed BENTOMAT CL GCL, SGI Report No. SGI1029, 3 August 2001, Unpublished.
- Trauger, R.J. and J. Burgio (1994) "Geosynthetics Solve Wetlands Mitigation Problems." Geotechnical Fabrics Report, Vol. 12, No. 6, August 1994, pp. 16–21.
- Trauger, R., Swan, R.H., and X. Yuan, (1996), "Long-Term Internal Shear Strength of a Needle-punched Geosynthetic Clay Liner," Testing and Acceptance Criteria for Geosynthetic Clay Liners, ASTM STP 1308, Larry W. Well, Ed., American Society for Testing and Materials, Philadelphia, 1996, pp. 103–120.
- United States Department of Agriculture, Natural Resources Conservation Service (USD-NRCS) (1997) Part 651, Agricultural Waste Management Field Handbook, Appendix 10D.

BENTOMAT® CL and CLT GCLs

APPENDIX A ESTIMATING THE EFFECTS OF PREFERENTIAL SEAM FLOW ON LINER SYSTEM PERFORMANCE

TEST METHOD AND THEORY

As shown in Figure A-1, flux testing was performed on unseamed and seamed samples of BENTOMAT CL (SGI, 2001). For each test, the flow rate was monitored over time for several applied hydrostatic pressures. The measured quantity of flow over a specific time interval was then used to calculate the unit flow rate. The unit flow rate is defined as the total measured inflow divided by the product of the liner area and the testing time, as shown in the following equation:

$$q = Q_t / (A_s \cdot \Delta t), \text{ where:} \quad (\text{Equation A-1})$$

q = unit flow through the entire seamed or unseamed liner specimen
 Q_t = total measured flow
 A_s = area of the entire seamed or unseamed liner specimen
 Δt = time interval during which the total flow is measured

When the unit flow rate for the seamed test is subtracted from the unit flow rate for the unseamed test, the resulting value is the amount of flow through the seam, or the preferential flow rate. However, this seamed flow rate does not directly correlate with field behavior because there is much more seam length per unit liner area in the test chamber than actually occurs in the field. Therefore a seam correction factor must be applied.

From Figure A-2, it is calculated that there are 3.42 m of seam/sqm of liner area in the test apparatus. From Figure A-3, it is calculated that there are only 0.2483 m of seam/sqm of liner deployed in the field. Therefore, the calculated value of seam flow from the lab testing overstates the actual field seam flow by a factor of $3.42 / 0.2483 = 13.7$. This correction factor is applied to the test results as explained below.

TEST RESULTS

Comparative testing between seamed and unseamed BENTOMAT CL samples was performed at three different hydraulic pressures: 30, 60, and 90 psi (207, 413, and 620 kPa). Table A-1 summarizes the results and calculates the seam flow by subtraction. The seam correction factor was then applied to the data in order to calculate the expected seam flow per unit area of full-size BENTOMAT CL panels deployed in the field (column 6).

By adding the unseamed flow results (column 1) to the corrected seam flow (column 6), the resulting value is the total amount of leakage expected in a field deployment of BENTOMAT CL. These values are presented in Table A-2. The value of $4.05 \times 10^{-10} \text{ m}^3/\text{m}^2/\text{s}$ is used for design purposes in Section 2.3 of this manual.

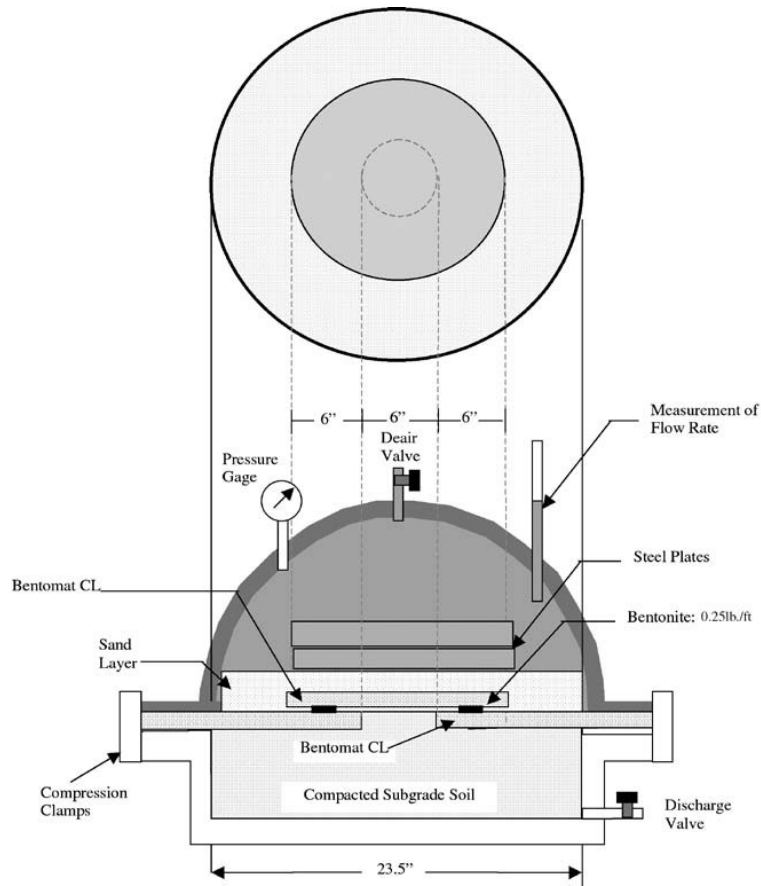

Figure A-1. Schematic diagram of testing apparatus used to determine overlapped seam flow through BENTOMAT CL. Figure

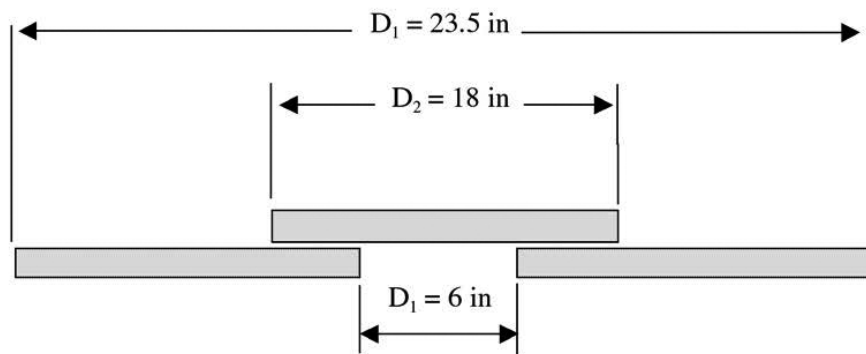

Figure A-2. Calculation of seam coverage factor in test apparatus.

$$A_{\text{total}} = \pi D^2 / 4 = (3.14) (23.5^2) / 4 = 433.5^2 \text{ in} = 0.28 \text{ m}^2$$

$$\text{Length of seam} = \pi (D_1 + D_2) / 2 = 37.68 \text{ in} = 0.957 \text{ m}$$

$$\text{Seam Coverage Factor } (C_s) = 0.957 \text{ m} / 0.28 \text{ m}^2 = 3.42 \text{ m/m}^2$$

There are 3.42 m of seam per m² of liner in the testing apparatus.

BENTOMAT® CL and CLT GCLs

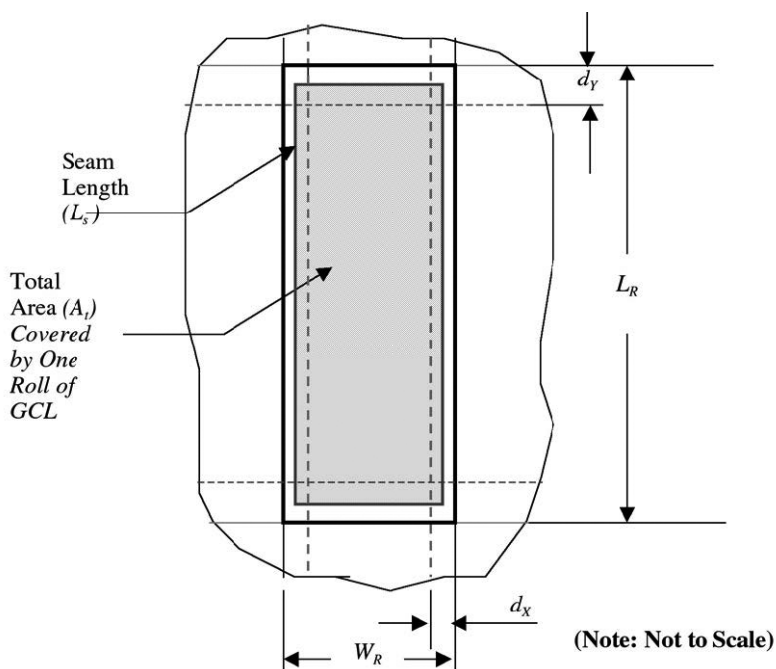

Figure A-3. Calculation of seam coverage factor for multiple rolls of BENTOMAT CL deployed in a large area.

The total area A_t covered by one roll of BENTOMAT CL is:

$$A_i = (W_R - d_x)(L_R - d_y)$$

where:

W_R and L_R = GCL roll width and length, respectively, and
 d_x and d_y = overlap at the roll edge and end, respectively.

The total seam length L_s (i.e., perimeter around the unseamed area) is:

$$L_s = 2(W_R - d_x) + 2(L_R - d_y)$$

In the field, with multiple rolls laid adjacent to each other, only half of the perimeter of any one roll is actually seamed. The actual seam coverage C_s can be expressed as:

$$C_s = [(W_R - d_x) + (L_R - d_y)] / [(W_R - d_x)(L_R - d_y)]$$

The preceding equation is now used to determine the seam coverage factor for BENTOMAT CL rolls that are 45.7 m (150 ft) long and 4.57 m (15 ft) wide. We will assume that the overlap is 150 mm (0.5 ft) on the longitudinal edges and 300 mm (1 ft) on the ends of the rolls. Thus,

$$W_R = 4.57$$

$$L_R = 45.7$$

$$d_x = 0.15$$

$$d_y = 0.3$$

$$C_s = [(4.57 - 0.15) + (45.7 - 0.3)] / [(4.57 - 0.15)(45.7 - 0.3)]$$

$$C_s = 0.2483 \text{ m/m}^2$$

There are 0.2483 m of seam per m^2 of liner in a typical field application.

1 HYDRAULIC PRESSURE (PSI/FT HEAD)	2 UNSEAMED FLOW (M ³ /M ² /S)	3 SEAMED FLOW (M ³ /M ² /S)	4 FLOW DIFFERENCE (M ³ /M ² /S)	5 SEAM CORRECTION FACTOR	6 FIELD SEAM FLOW (M ³ /M ² /S)
10 / 23	Not tested	1.77 x 10 ⁻¹¹	N/A	N/A	N/A
20 / 46	Not tested	3.37 x 10 ⁻¹⁰	N/A	N/A	N/A
30 / 69	1.71 x 10 ⁻¹⁰	3.37 x 10 ⁻⁹	3.20 x 10 ⁻⁹	13.7	2.34 x 10 ⁻¹⁰
60 / 138	5.91 x 10 ⁻¹⁰	1.56 x 10 ⁻⁹	9.69 x 10 ⁻⁹	13.7	7.07 x 10 ⁻¹⁰
90 / 128	6.95 x 10 ⁻¹⁰	3.18 x 10 ⁻⁹	2.49 x 10 ⁻⁹	13.7	1.81 x 10 ⁻¹⁰

Table A-1. Summary of laboratory testing of seamed and unseamed BENTOMAT CL, with the seam correction factor used to calculate net seam flow.

HYDRAULIC PRESSURE (PSI/FT HEAD)	UNSEAMED FLOW (M ³ /M ² /S)	FIELD SEAM FLOW (M ³ /M ² /S)	TOTAL FLOW (M ³ /M ² /S)
10 / 23	Not tested	N/A	N/A
20 / 46	Not tested	N/A	N/A
30 / 69	1.71 x 10 ⁻¹⁰	2.34 x 10 ⁻¹⁰	4.05 x 10 ⁻¹⁰
60 / 138	5.91 x 10 ⁻¹⁰	7.07 x 10 ⁻¹⁰	1.29 x 10 ⁻⁹
90 / 208	6.95 x 10 ⁻¹⁰	1.81 x 10 ⁻¹⁰	8.76 x 10 ⁻¹⁰

Table A-2. Summing the unseamed flow rate and seam flow rate to obtain a total flow rate expected for a seamed system of BENTOMAT CL deployed in the field.

BENTOMAT® CL and CLT GCLs

APPENDIX B EVAPORATION NOMOGRAPH

EVAPORATION

Data on evaporation from lakes and reservoirs are not extensive. But there are formulas by which it may be computed. One of these: by Fitzgerald, has the form, $E_n = (S - F)(1 + V/2)/60$: where E_n = evaporation rate, in./hr.; S = vapor pressure of water at water temperature, in. Hg; F = vapor pressure existing in the air; and v = wind velocity, mph. Wind velocities are at the water surface and may be taken at one-half those recorded at an elevated station such as the Weather Bureau stations. For larger reservoirs, however, Weather Bureau values give results in close agreement with direct measurements.

An alternative and substantially equivalent formula is given by Fitzgerald in more usable terms. Somewhat simplified and transformed: it is: $E_n = 0.0002 (T_n - T_{wb})(1 + v/2)$: where T_n and T_{wb} are the air temperature and wet-bulb temperature, respectively. The monogram is based on the second formula. It includes the relative humidity for convenience.

EXAMPLE

Assume the "normal" or long-term monthly temperature, relative humidity, and wind velocity for a certain location are 80°F, 58%, and 8 mph; what is the "normal" wet-bulb temperature, and what is the evaporation rate per hour and per month of 31 days?

SOLUTION

Step 1. Line 80°F. on T_a scale with 58% on R scale, extend to Pivot line and mark. Also read wet-bulb temperature as 69°F where line crossed T_{wb} scale. Step 2, from marked position Pivot line, connect with 8 mph on V scale, extend to E_n scale, and read evaporation rate as 0.011 in./hr. The evaporation rate per month = $0.011 \times 24 \times 31 = 8.184$ in.

Reprinted from OIL & GAS PETROCHEMICAL EQUIPMENT, March 1974 issue.

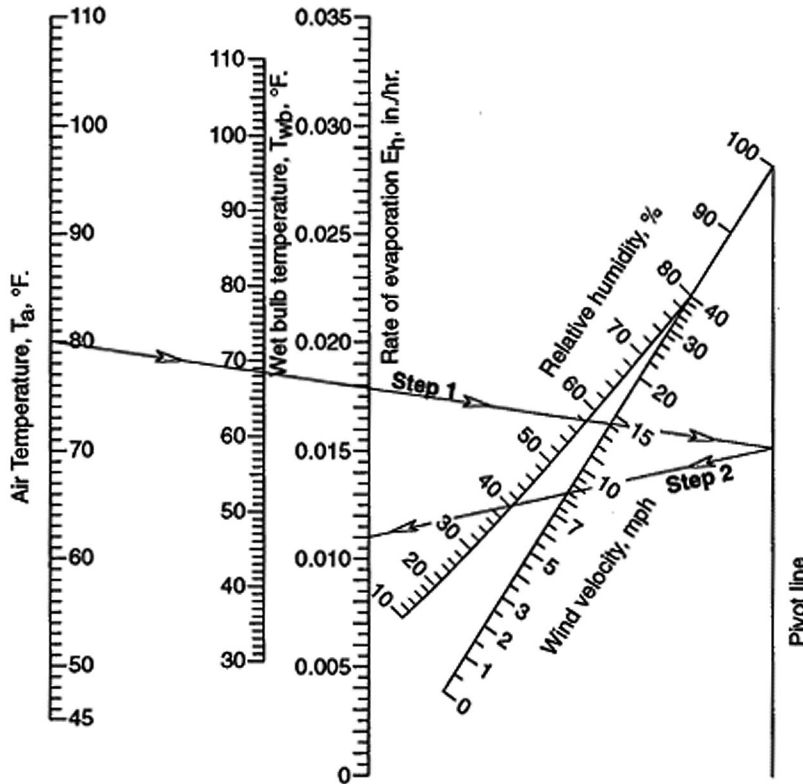

PAN EVAPORATION RATES FOR THE UNITED STATES

(Farnsworth, et. al. 1982)

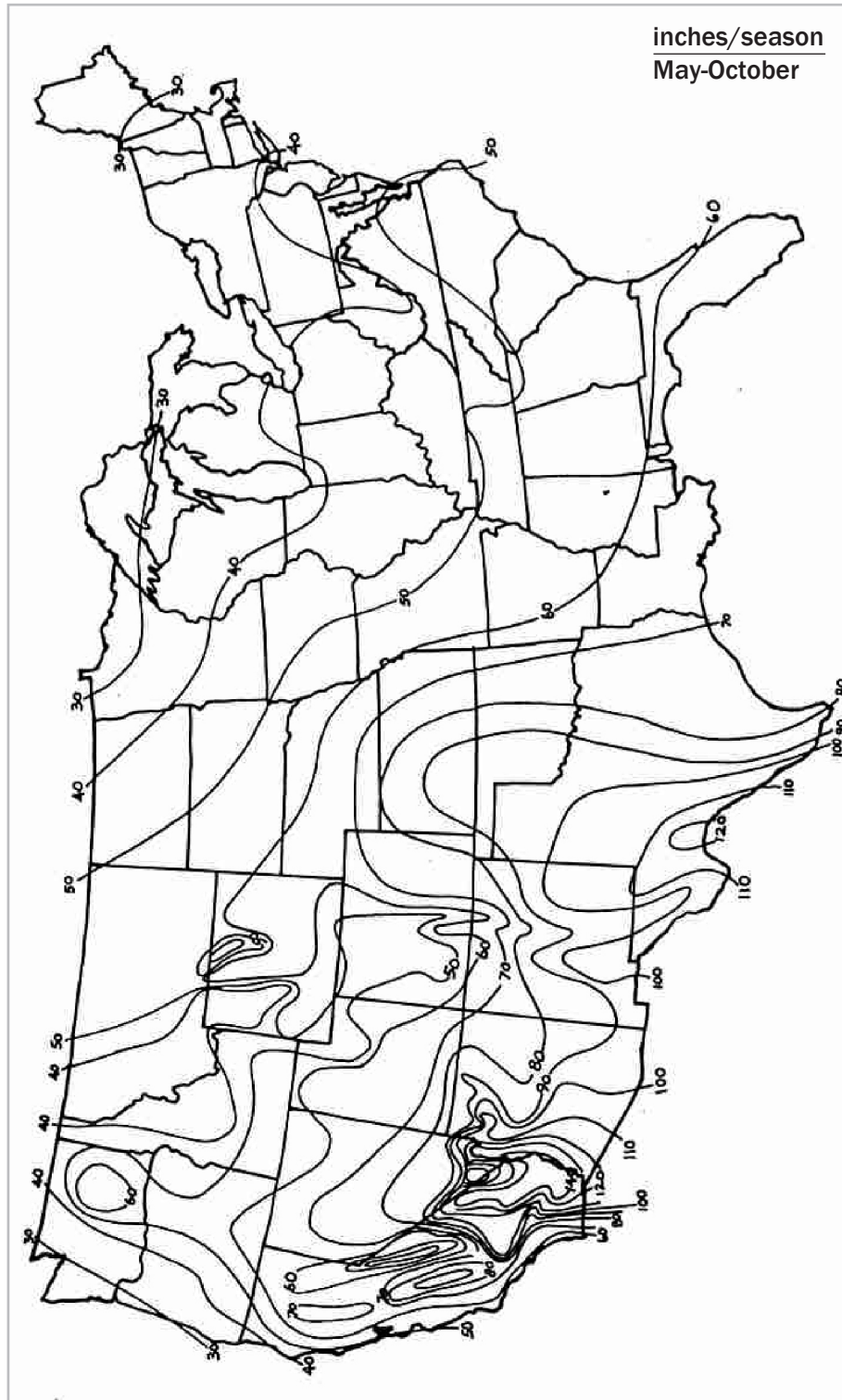

BENTOMAT® CL and CLT GCLs

APPENDIX C EXAMPLE CALCULATION FOR SLOPE STABILITY

This procedure demonstrates how a mathematical model can be used to assess slope stability for an BENTOMAT CL-lined pond in cases where a simple sliding block analysis is inconclusive. It is not intended to derive or explain the model. Readers are referred to the full text of the source paper for detailed explanations.

The Giroud and Beech stability calculation differs from the simplified “sliding block” model presented in Section 2.2, because it includes consideration of toe buttressing and liner anchorage, both of which contribute to stability. The method does not include pore water (seepage) forces, which can contribute to instability. In a water containment application, seepage forces can occur during rapid drawdown of the water such as might occur in a fire pond application. In ordinary use, however, rapid drawdown is not likely and is not considered herein

Slope Stability Equation from Giroud and Beech

$$\alpha = \frac{\gamma_c T_c^2}{\sin 2\beta} \left[\left(\frac{2H \cos \beta}{T_c} - 1 \right) \left(\frac{\sin(\beta - \phi_i)}{\cos \phi_i} \right) - \left(\frac{\sin \phi_c}{\cos(\beta + \phi_c)} \right) \right]$$

Where:

- α = Liner tension per unit width
- γ_c = Unit weight of cover material
- T_c = Thickness of cover material
- β = Slope angle, degrees
- H = Slope height
- ϕ_i = Minimum interface friction angle, degrees
- ϕ_c = Internal friction angle of cover material, degrees

And:

$$\tan \phi_m = \frac{\tan \phi_c}{FS}$$

Where:

- $\tan \phi_m$ = mobilized friction angles, with factor of safety included
- FS = factor of safety (engineer-determined)

Reference: Giroud, J.P., and J.F. Beech (1989) “Stability of Soil Layers on Geosynthetic Lining Systems,” *Geosynthetics '89*, Industrial Fabrics Association International, pp. 35–46.

Using this calculation, if the result (a) is negative, then the liner system is not in tension and can be considered stable. If is positive, then the geosynthetic component of the lining system above the critical interface will be in tension. This is because the driving force cannot be transferred through frictional resistance. If the tension exceeds the allowable amount for this component, failure could occur.

The value for allowable tension is determined by the ultimate tensile strength of the liner, which is reduced by an appropriate percentage to ensure that the liner is not excessively stressed. Assuming BENTOMAT CL is used, existing data indicates that its ultimate strength is 780 lbs/ft (11.4 kN/m). Assuming that the liner will still remain functional in the long term with 40% of this load applied, the “allowable” tensile stress is 312 lbs/ft (4.6 kN/m). If the designer opts to eliminate all tension on the liner, then the analysis is performed to ensure that a=0. An example calculation is provided below.

EXAMPLE:

A pond is to be constructed on compacted sand with a 2.5H:1V interior side slope. There will be 18 inches (450 mm) of sand cover on the BENTOMAT CL (allowable tension = 312 lb/ft or 4.6 kN/m), with the membrane component of the pond liner facing the subgrade. The slope is 50 feet (15.2 m) long. The designer prefers a safety factor of 1.3. Determine if the slope will be stable both in the as-constructed and submerged conditions.

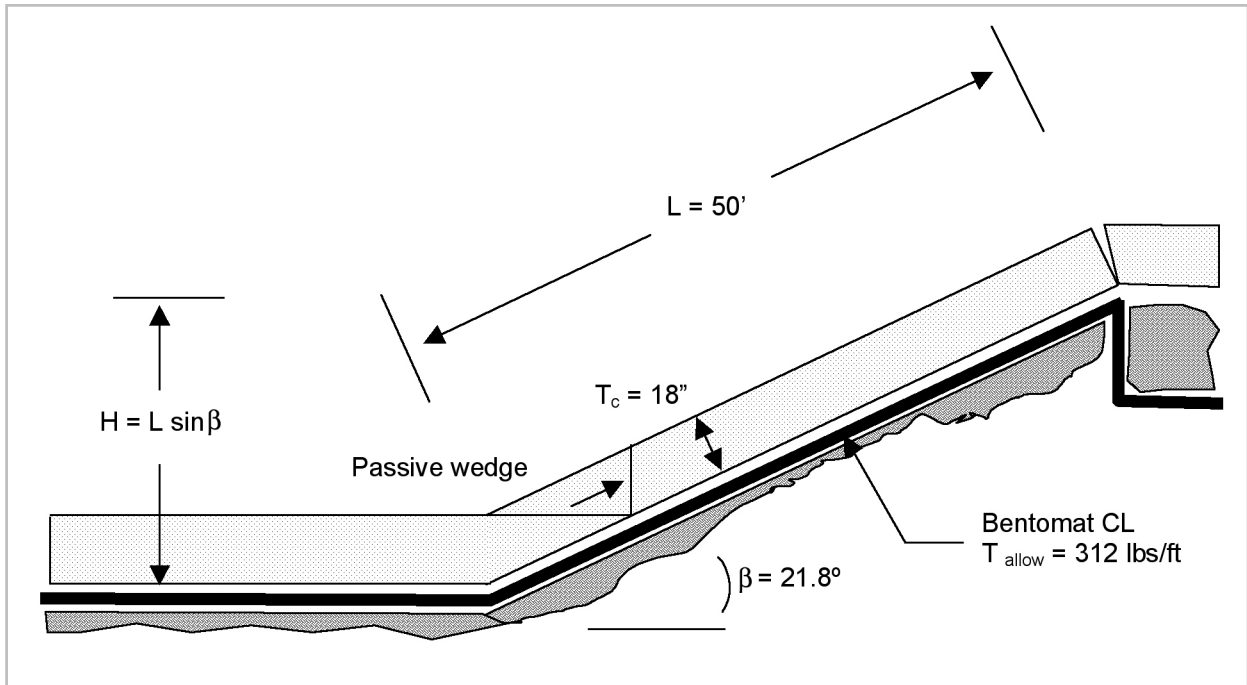

ANSWER: From Table C-1, the compacted density of the sand cover soil layer can be reasonably estimated as 130 lbs/ft³ (20.42 kN/m³). The friction angle of the sand is assumed to be 30 degrees (23.9 degrees with FS=1.3). And from the data in Table 2-1, the weakest interface is that between the membrane component of BENTOMAT CL and the sand. For purposes of this calculation, the interface friction value is assumed to be 24 degrees (18.9 degrees with FS=1.3), although site specific tests are always recommended. Finally, with a 2.5H:1V slope 50 feet (15.2 m) long, it can be calculated that the slope height (H) is 18.6 ft (5.67 m). Using the Giroud and Beech stability equation,

$$\alpha = \frac{(130)(1.5)^2}{\sin 2(21.8)} \left[\left(\frac{2(18.6) \cos(21.8)}{1.5} - 1 \right) \left(\frac{\sin(21.8 - 18.9)}{\cos 18.9} \right) - \left(\frac{\sin 23.9}{\cos(21.8 + 23.9)} \right) \right]$$

$$\alpha = 251 \text{ lb/ft (3.66 kN/m)}$$

The answer is positive, indicating that there is tension on the liner. However, the amount of tension is less than the allowable value, so the slope is stable. To evaluate the submerged state, the buoyant force of water (62.4 lbs/ft³ or 9.8 kN/m³) is subtracted from the unit weight of the soil. When the calculation is repeated, the resulting tension on the liner system = 131 lb/ft (1.91 kN/m) and the slope is still considered stable.

BENTOMAT® CL and CLT GCLs

Had the simple sliding block calculation been performed using these same values, the results would have been:

$$FS = \frac{\tan \phi_c}{\tan \beta} = \frac{\tan 24}{\tan 21.4} = 1.13$$

With a desired factor of safety of 1.3, the simplified analysis would have shown that the slope is not acceptably stable. Thus the modified analysis method can be used to demonstrate stability in cases where the simplified method does not.

SYMBOL	DESCRIPTION	DENSITY (LB./FT ³) MIN., MAX.	DENSITY (KN/ M ³) MIN., MAX.	FRICTION
GW	Well-graded, clean sands, gravel-sand mixtures	125, 135	19.64, 21.21	>38
GP	Poorly graded, clean gravels, gravel-sand mixtures	115, 125	18.07, 19.64	>37
GM	Silty gravels, poorly graded gravel-sand silt	120, 135	18.85, 21.21	>34
GC	Clayey gravels, poorly graded gravel-sand-clay	115, 130	18.07, 20.42	>31
SW	Well-graded clean sands, gravelly sands	110, 130	17.28, 20.42	38
SP	Poorly graded clean sands, sand-gravel mix	100, 120	15.71, 18.85	37
SM	Silty sands, poorly graded sand silt mix	110, 125	17.28, 19.64	34
SM-MC	Sandy-silt-clay mix with slightly plastic fines	110, 130	17.28, 20.42	33
SC	Clayey sands, poorly graded sand-clay mix	105, 125	16.50, 19.64	31
ML	Inorganic silts and clayey silts	95, 120	14.92, 18.85	32
ML-CL	Mixture of organic silt and clay	100, 120	15.71, 18.85	32
CL	Inorganic clays of low-to-medium plasticity	95, 120	14.92, 18.85	28
OL	Organic silts and silt-clays, low plasticity	80, 100	12.57, 15.71	—
MH	Inorganic clayey silts, elastic silts	70, 95	11.00, 14.92	25
CH	Inorganic clays of high plasticity	75, 105	11.78, 16.50	19
OH	Organic and silty clays	65, 100	10.21, 15.71	—

Table C-1. Typical Properties of Compacted Soils.
Reference: Construction Planning: Equipment and Methods, 4th Ed.

RATIO (H:V)	PERCENT	DEGREES
0.5:1	70.5	63.4
1:1	50	45.0
1.5:1	37.4	33.7
2:1	29.5	26.6
2.5:1	24.2	21.8
3:1	20.5	18.4
3.5:1	17.7	15.9
4:1	15.6	14.0
5:1	12.6	11.3
6:1	10.6	9.5
7:1	9.0	8.1
8:1	7.9	7.1
9:1	7.0	6.3
10:1	6.3	5.7

Table C-2. Slope Conversions.

BENTOMAT® CL and CLT GCLs

APPENDIX D RAMP DESIGN PROCEDURE

In certain water containment applications, it may be necessary to include a ramp to provide vehicular access to the interior of the pond. Ramps may be needed when earthmoving equipment is used to remove accumulated sludge in a wastewater lagoon or sediment in a sedimentation basin. A ramp may also be included in a decorative pond design in order to provide boat access. In all of these cases, the liner system must be strong enough to support the static and dynamic loads that vehicles will impose on the slopes. This procedure (provided courtesy of Tensar) helps the designer calculate these loads and then determine whether additional reinforcing members are needed to support them.

EXAMPLE:

A ramp sloping at 12 degrees is constructed leading into a sedimentation basin. The ramp is 10 feet (3 m) wide and 100 feet (30 m) long and is covered with 2 feet (600 mm) of sandy soil at 130 lbs/ft³ (2,082 Kg/m³). How much reinforcement is needed to ensure a factor of safety of 2.0 when a 30,000 lb (13,605 Kg) vehicle is moving down the ramp and applies its brakes? The critical friction angle in the liner system is the membrane component of the BENTOMAT CL against the subgrade, which is 24 degrees. Assume that braking applies a downward force that is 30% of the vehicle weight.

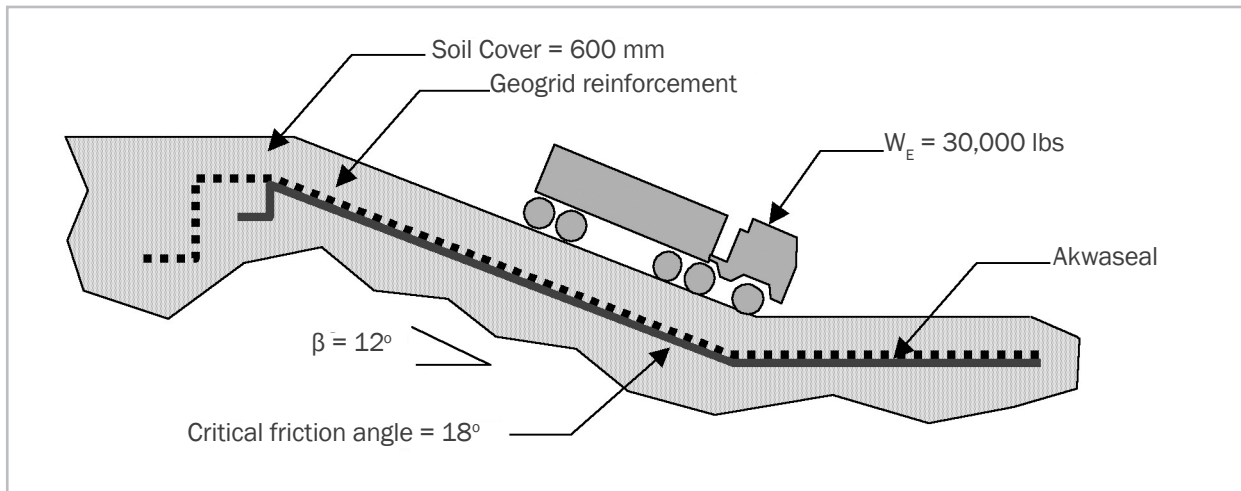

ANSWER:

As with other stability calculations, it is necessary to calculate the driving forces and resisting forces. The driving forces include the weight of the ramp cover soil (WR), the weight of the equipment driving on the slope (WE), and the braking force (FB). The resisting forces include the frictional resistance between the liner and subgrade and tension on any reinforcing component such as a geogrid.

$$W_r = (100 \text{ ft} \times 10 \text{ ft} \times 2 \text{ ft})(130 \text{ lbs/ft}^3) = 260,000 \text{ lbs}$$

$$W_e = 30,000 \text{ lbs}$$

$$F_b = 0.3 \times W_e = (0.3)(30,000) = 9,000 \text{ lbs}$$

$$\begin{aligned} \text{Frictional resistance} = F_r &= (W_r + W_e) \cos 12 \tan 24 \\ &= (260,000 + 30,000)(0.978)(0.445) = 126,210 \text{ lbs} \end{aligned}$$

$$\begin{aligned} \text{Driving forces (static conditions)} = F_{ds} &= (W_r + W_e) \sin 12 \\ &= (260,000 + 30,000)(0.208) = 60,320 \text{ lbs} \end{aligned}$$

$$\begin{aligned}\text{Driving forces (dynamic conditions)} &= F_{DD} = F_{DS} + F_B \\ &= 60,320 + 9,000 = 69,320 \text{ lbs}\end{aligned}$$

Factor of safety = FS = Resisting forces/driving forces

$$FS = \frac{F_R + T_{req}}{F_{Ds} + F_B}$$

Tension required for reinforcement = T_{req}

$$\begin{aligned}T_{req} &= FS (F_{Ds} + F_B) - F_R \\ &= 2 (60,320 + 9,000) - 126,210 = \mathbf{12,430 \text{ lbs or } 1,234 \text{ lbs/ft ramp width}}\end{aligned}$$

This is the total amount of tension required to be carried by the geogrid reinforcement. As an example, a Tensar UX1100HS geogrid has a long-term allowable tensile strength of 1,570 lbs/ft in sand. Therefore, this ramp would be stable with an FS > 2.0 using a Tensar UX1100HS geogrid placed on the liner, with the 2 feet of cover soil backfill placed over the geogrid.

It should be noted that the factor of safety without the geogrid is 1.8. This is because the critical friction angle is greater than the slope angle. This implies stability although perhaps not with a sufficient degree of conservatism as would be warranted in a ramp design.

BENTOMAT® CL and CLT GCLs

APPENDIX E POND LINER DESIGN CHECKLIST

CHECKLIST ITEM	OUTCOME (CHECK ONE)		
	ACCEPTABLE	NOT ACCEPTABLE	NOT APPLICABLE
UNIVERSAL DESIGN PARAMETERS			
Site selection			
Groundwater level is below bottom of pond			
Subgrade soils can be compacted and smoothed			
Soil is not excessively rocky			
Trees and roots can be removed			
Soil has adequate bearing capacity			
Slope Stability			
Design slopes do not exceed 4H:1V			
Design calculations indicate stability			
Slope lengths do not exceed those listed in Table 2-3			
Hydraulic Performance			
Bentomat CL flux rate meets project requirements			
Evaporative losses evaluated			
Pond will contain fresh water only			
Pond will not contain high levels of contaminants			
APPLICATION-SPECIFIC DESIGN PARAMETERS			
Details for inlet/outlet structures are complete			
Details for terminations are complete			
Indicator layer planned for sediment removal			
Hard armor system designed for shoreline			
Rapid drawdown issues considered			
Groundwater elevation considered			
Hydrostatic uplift potential evaluated			
Entry/exit ramps designed			
Pond perimeter favorable for easy access			
INSTALLATION-RELATED DESIGN PARAMETERS			
Suitable handling equipment available			
Contractor aware of need to protect liner			
Unloading and storage conditions recognized			
Subgrade prepared to receive liner			
Runout and anchor trench with proper dimensions			
Suitable quality and quantity of cover soil available			

NOTE:

This checklist is merely a guideline for the designer's convenience and is not intended as a replacement for a project-specific design.

APPENDIX F

GUIDELINES FOR ASSESSING THE CONDITION OF HYDRATED LINER

It is often asked whether “premature hydration” affects BENTOMAT CL to the extent where it should be “removed and replaced”. The term “premature” is used because excessive hydration is only a concern when the liner is uncovered. Once a modest confining cover (12 inches of soil) is applied over the liner, the bentonite cannot exert enough swelling force to delaminate the product, nor can it absorb enough water to become overly plastic. A few years ago, specifiers began to include provisions requiring the removal and replacement of all liner that was hydrated before being covered. However, this “remove and replace” practice is not always necessary.

BENTOMAT CL is needlepunched, meaning that it is held together with needlepunched fibers. The needlepunched construction of BENTOMAT CL provides a mechanical bond that cannot be overcome by the swelling bentonite. In other words, BENTOMAT CL can withstand unconfined hydration without losing its integrity. This is why BENTOMAT CL can be successfully deployed even in standing water for short periods without adverse impacts. However, this does not mean that CETCO recommends such installation practices. CETCO advises that these instances be evaluated on a case-by-case basis. For example, the duration that the material was exposed, the degree of its hydration, the location of BENTOMAT CL within the liner system, and the bearing loads it will be subjected to during construction are all factored into a recommendation.

When assessing whether to remove and replace any prematurely hydrated BENTOMAT CL, an examination of the hydrated areas should be conducted in order to verify that:

1. The geotextiles have not been separated, torn, or otherwise damaged.
2. There is no evidence that the needlepunching between the geotextiles has been compromised.
3. The BENTOMAT CL does not leave deep indentations when it is walked upon.
4. The overlapped and bentonite-enhanced seams are intact.

If these conditions are met, then BENTOMAT CL probably may remain in place. Although it may contain more water than it would have under soil or geosynthetic cover, this water will be drained from the pond liner when consolidation occurs as normal loads are applied. The end result will be a water content in the formerly unconfined areas that is equivalent to that in the confined areas. Even if BENTOMAT CL is hydrated to the extent that bentonite is displaced under foot, it may be possible to allow the material to air-dry such that bentonite is no longer displaced by point load. This is why it is not necessary to specify an absolute numerical moisture content criterion to decide whether to remove and replace BENTOMAT CL. Again, removal and replacement would not be necessary, provided there is no visible evidence of damage.

Premature hydration is an extremely common occurrence, and BENTOMAT CL was designed to sustain it without requiring removal and replacement. CETCO has found that such cases are a rare exception and occur only as a result of prolonged hydration followed by direct vehicular contact. For this reason, CETCO estimates that over 99% of prematurely hydrated BENTOMAT CL does not require removal.

BENTOMAT® CL and CLT GCLs

APPENDIX G
BENTOMAT CL AND CLT INTERFACE SHEAR TEST DATA

COLLOID ENVIRONMENTAL TECHNOLOGIES COMPANY
INTERFACE DIRECT SHEAR TESTING (ASTM D 6243)

Test Series 1: graded aggregate base (GAB) material against the membrane side of Bentomat CL GCL under soaked conditions

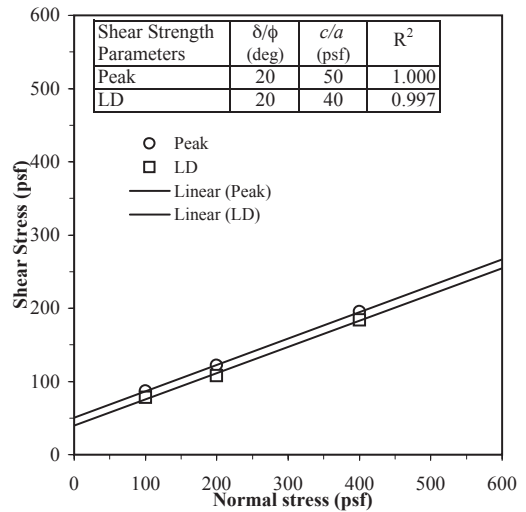
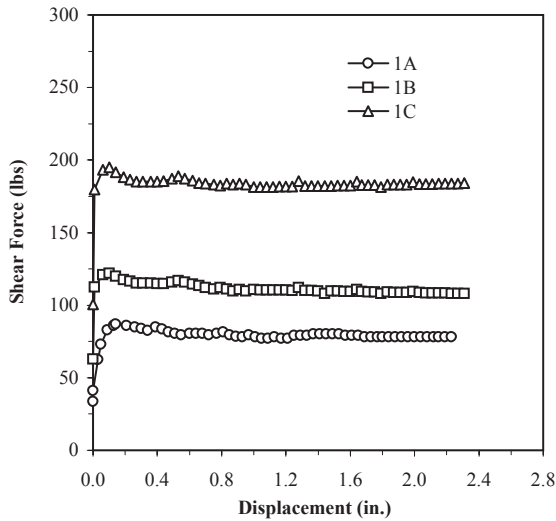

Test No.	Shear Box Size (in. x in.)	Normal Stress (psf)	Shear Rate (in./min)	Soaking		Consolidation		Lower Soil			Upper Soil			GCL		Shear Stress		Failure Mode
				Stress (psf)	Time (hour)	Stress (psf)	Time (hour)	γ_{di} (pcf)	ω_i (%)	ω_f (%)	γ_{di} (pcf)	ω_i (%)	ω_f (%)	ω_i (%)	ω_f (%)	τ_p (psf)	τ_{LD} (psf)	
1A	12 x 12	100	0.040	200	24	-	-	-	-	-	128.5	6.1	6.8	31.6	126.9	87	78	(1)
1B	12 x 12	200	0.040	200	24	-	-	-	-	-	128.3	6.1	6.6	31.6	119.6	122	108	(1)
1C	12 x 12	400	0.040	200	24	-	-	-	-	-	128.4	6.1	6.0	31.6	100.0	195	184	(1)

Notes: (1) Sliding (i.e., shear failure) occurred between the soil and the membrane side of the GCL during each test.
 (2) The reported total-stress parameters of friction angle and adhesion were determined from a best-fit line drawn through the test data. Caution should be exercised in using these strength parameters for applications involving normal stresses outside the range of the stresses covered by the test series. The large-displacement (LD) shear strength was calculated using the shear force measured at the end of the test.

DATE OF TEST: 11 to 12 February 2002



SGI TESTING SERVICES, LLC

FIGURE NO.	B-1
PROJECT NO.	SGI2009
DOCUMENT NO.	SGI02045
FILE NO.	

**COLLOID ENVIRONMENTAL TECHNOLOGIES COMPANY
INTERFACE DIRECT SHEAR TESTING (ASTM D 6243)**

Test Series 2: silty sand material against the membrane side of Bentomat CL GCL under soaked conditions

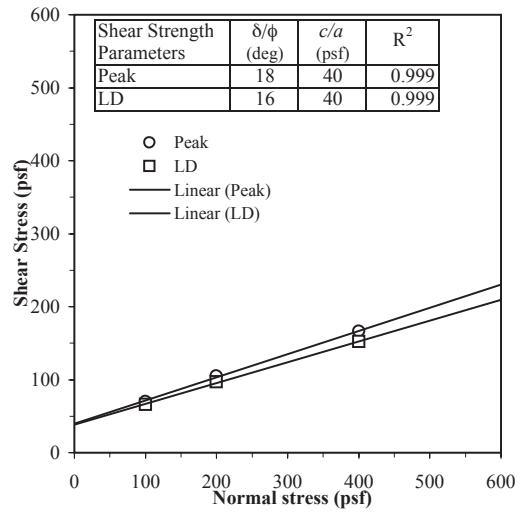
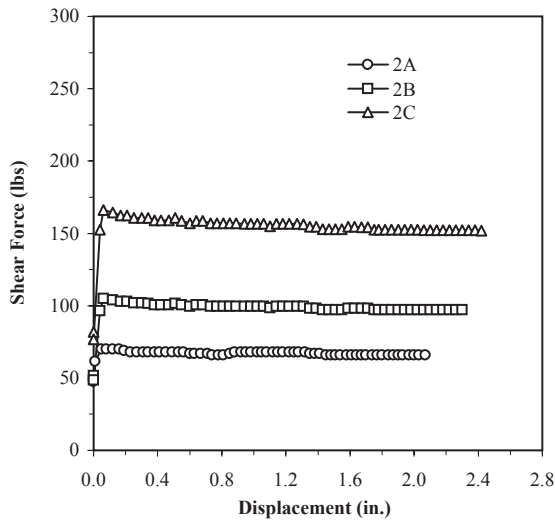

Test No.	Shear Box Size (in. x in.)	Normal Stress (psf)	Shear Rate (in./min)	Soaking		Consolidation		Lower Soil			Upper Soil			GCL		Shear Stress		Failure Mode
				Stress (psf)	Time (hour)	Stress (psf)	Time (hour)	γ_{di} (pcf)	ω_l (%)	ω_r (%)	γ_{di} (pcf)	ω_l (%)	ω_r (%)	ω_l (%)	ω_r (%)	τ_p (psf)	τ_{LD} (psf)	
2A	12 x 12	100	0.040	200	24	-	-	-	-	-	93.0	22.6	21.7	31.6	128.0	70	66	(1)
2B	12 x 12	200	0.040	200	24	-	-	-	-	-	93.2	22.6	21.4	31.6	120.3	105	97	(1)
2C	12 x 12	400	0.040	200	24	-	-	-	-	-	93.3	22.6	21.2	31.6	107.2	166	152	(1)

Notes: (1) Sliding (i.e., shear failure) occurred between the soil and the membrane side of the GCL during each test.
 (2) The reported total-stress parameters of friction angle and adhesion were determined from a best-fit line drawn through the test data. Caution should be exercised in using these strength parameters for applications involving normal stresses outside the range of the stresses covered by the test series. The large-displacement (LD) shear strength was calculated using the shear force measured at the end of the test.

DATE OF TEST: 13 to 14 February 2002



SGI TESTING SERVICES, LLC

FIGURE NO.	B-2
PROJECT NO.	SGI2009
DOCUMENT NO.	SGI02045
FILE NO.	

BENTOMAT® CL and CLT GCLs

COLLOID ENVIRONMENTAL TECHNOLOGIES COMPANY INTERFACE DIRECT SHEAR TESTING (ASTM D 6243)

Test Series 3: clay soil material against the membrane side of Bentomat CL GCL under soaked conditions

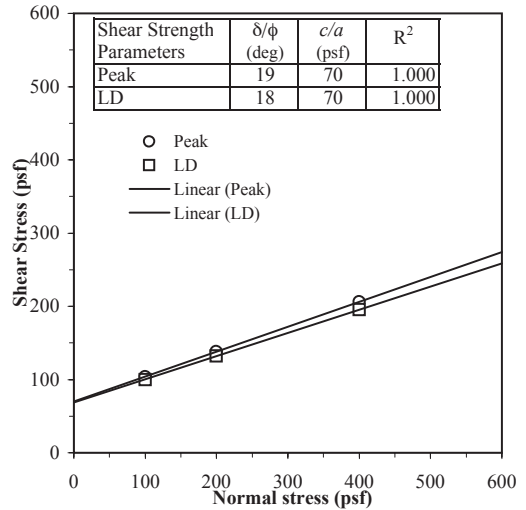
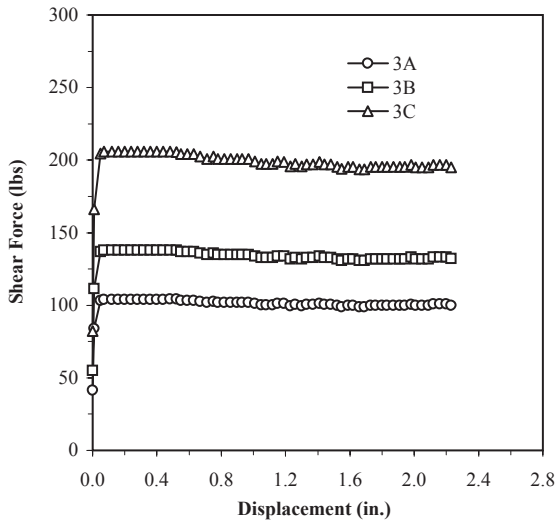

Test No.	Shear Box Size (in. x in.)	Normal Stress (psf)	Shear Rate (in./min)	Soaking		Consolidation		Lower Soil			Upper Soil			GCL		Shear Stress		Failure Mode
				Stress (psf)	Time (hour)	Stress (psf)	Time (hour)	γ_{di} (pcf)	ω_i (%)	ω_f (%)	γ_{di} (pcf)	ω_i (%)	ω_f (%)	ω_i (%)	ω_f (%)	τ_p (psf)	τ_{LD} (psf)	
3A	12 x 12	100	0.040	200	24	-	-	-	-	-	93.0	13.4	13.5	31.6	115.4	104	100	(1)
3B	12 x 12	200	0.040	200	24	-	-	-	-	-	93.2	13.4	13.5	31.6	100.0	138	132	(1)
3C	12 x 12	400	0.040	200	24	-	-	-	-	-	93.3	13.4	13.4	31.6	94.0	206	195	(1)

Notes: (1) Sliding (i.e., shear failure) occurred between the soil and the membrane side of the GCL during each test.
 (2) The reported total-stress parameters of friction angle and adhesion were determined from a best-fit line drawn through the test data. Caution should be exercised in using these strength parameters for applications involving normal stresses outside the range of the stresses covered by the test series. The large-displacement (LD) shear strength was calculated using the shear force measured at the end of the test.

DATE OF TEST: 14 to 15 February 2002



SGI TESTING SERVICES, LLC

FIGURE NO.	B-3
PROJECT NO.	SGI2009
DOCUMENT NO.	SGI02045
FILE NO.	

**CETCO LINING TECHNOLOGIES - 2012 ANNUAL SHEARING TEST PROGRAM
GCL DIRECT SHEAR TESTING (ASTM D 6243)**

Upper Shear Box: Silty sand compacted to approximately 95% of max standard Proctor density at OMC ($\gamma_{dmax} = 98.5$ pcf, OMC = 19.0%)/
Bentomat CL GCL (Lot #200902CV/Roll #1) with black woven geotextile side up against silty sand

Lower Shear Box: Steel grip (Note: by using steel grip, shear failure was forced to occur at interface between the silty sand and woven geotextile side of GCL)

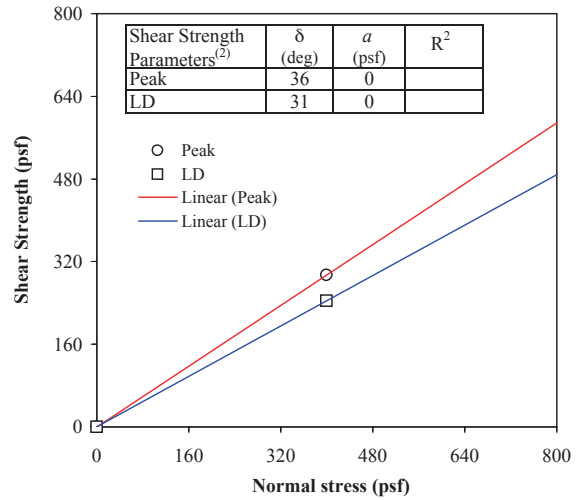
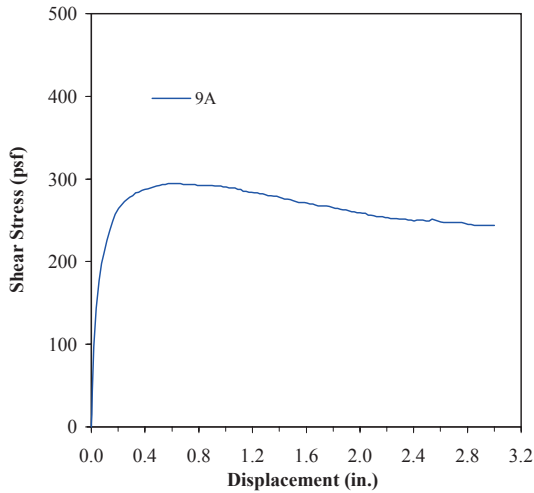

Test No.	Shear Box Size (in. x in.)	Normal Stress (psf)	Shear Rate (in./min)	GCL Soaking		Consolidation		GCL			Soil Shear Strength Parameters				Shear Strength ⁽¹⁾		Coefficient of Direct Sliding	
				Stress (psf)	Time (hours)	Stress (psf)	Time (hours)	ω_i (%)	ω_s (%)	ω_f (%)	ϕ_p (deg)	c_p (psf)	ϕ_{LD} (deg)	c_{LD} (psf)	τ_p (psf)	τ_{LD} (psf)	C_{DS-P}	C_{DS-LD}
9A	12 x 12	400	0.04	200	24	400	24			99.8	32	75	31	30	294	244	0.91	0.90
9B	12 x 12																	
9C	12 x 12																	

NOTES:

(1) Sliding (i.e., shear failure) occurred at the interface between silty sand and woven geotextile side of GCL.

(2) The reported total-stress secant friction angle was defined as $\delta_{secant} = \arctan(\text{shear strength}/\text{normal strength})$. Caution should be exercised in using the secant friction angle for applications involving normal stresses other than the test normal stress. The large-displacement (LD) shear strength was calculated using the shear force measured at the end of the test.



SGI TESTING SERVICES, LLC

DATE OF TEST:	11/9/2012
FIGURE NO.	C-1
PROJECT NO.	SGI12006
DOCUMENT NO.	
FILE NO.	



BENTOMAT® CL and CLT GCLs

CETCO LINING TECHNOLOGIES - 2012 ANNUAL SHEARING TEST PROGRAM GCL DIRECT SHEAR TESTING (ASTM D 6243)

Upper Shear Box: Clay soil compacted to approximately 95% of max standard Proctor density at 3% + OMC ($\gamma_{dmax} = 114$ pcf, OMC = 15.0%)
Bentomat CL GCL (Lot #200902CV/Roll #1) with black woven geotextile side up against clay soil

Lower Shear Box: Steel grip (Note: by using steel grip, shear failure was forced to occur at the interface between clay soil and woven geotextile side of GCL)

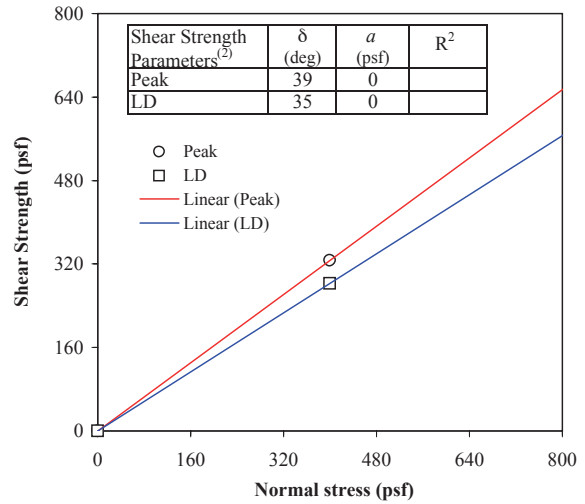
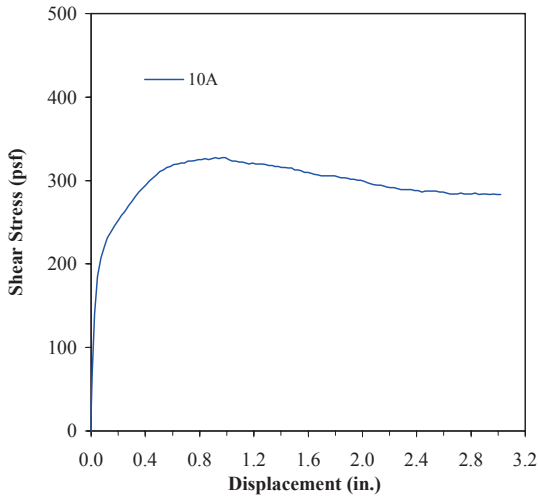

Test No.	Shear Box Size (in. x in.)	Normal Stress (psf)	Shear Rate (in./min)	GCL Soaking		Consolidation		GCL			Soil Shear Strength Parameters				Shear Strength ⁽¹⁾		Coefficient of Direct Sliding	
				Stress (psf)	Time (hours)	Stress (psf)	Time (hours)	ω_i (%)	ω_s (%)	ω_r (%)	ϕ_p (deg)	c_p (psf)	ϕ_{LD} (deg)	c_{LD} (psf)	τ_p (psf)	τ_{LD} (psf)	C_{DS-P}	C_{DS-LD}
10A	12 x 12	400	0.04	200	24	400	24			105.5					327	283		
10B	12 x 12																	
10C	12 x 12																	

NOTES:

(1) Sliding (i.e., shear failure) occurred at the interface between clay soil and geotextile side of GCL.

(2) The reported total-stress secant friction angle was defined as $\delta_{secant} = \arctan(\text{shear strength}/\text{normal strength})$. Caution should be exercised in using the secant friction angle for applications involving normal stresses other than the test normal stress. The large-displacement (LD) shear strength was calculated using the shear force measured at the end of the test.



SGI TESTING SERVICES, LLC

DATE OF TEST:	11/9/2012
FIGURE NO.	C-2
PROJECT NO.	SGI12006
DOCUMENT NO.	
FILE NO.	

CETCO LINING TECHNOLOGIES - 2012 ANNUAL SHEARING TEST PROGRAM

GCL DIRECT SHEAR TESTING (ASTM D 6243)

Upper Shear Box: Graded aggregate base (GAB) material compacted to approximately 95% of max standard Proctor density at OMC $V_{dmax} = 137$ pcf, OMC = 5.7%)/ Bentomat CL GCL (Lot #200902CV/Roll #1) with black woven geotextile side up against GAB material

Lower Shear Box: Steel grip (Note: by using steel grip, shear failure was forced to occur at the interface between GAB material and geotextile side of GCL)

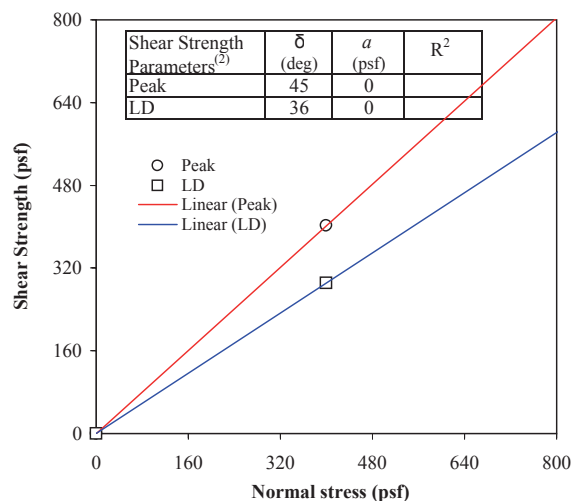
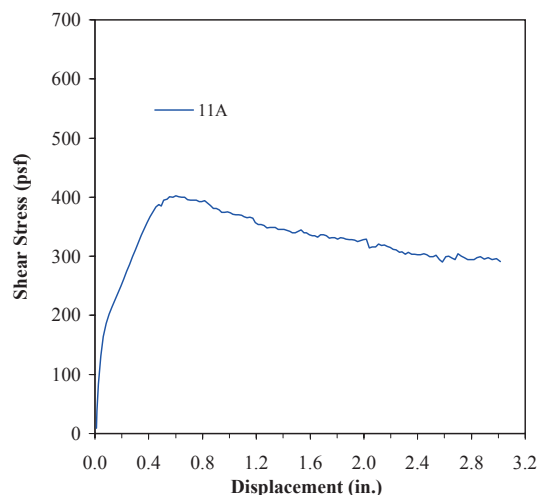

Test No.	Shear Box Size (in. x in.)	Normal Stress (psf)	Shear Rate (in./min)	GCL Soaking		Consolidation		GCL			Soil Shear Strength Parameters				Shear Strength ⁽¹⁾		Coefficient of Direct Sliding	
				Stress (psf)	Time (hours)	Stress (psf)	Time (hours)	ω (%)	ω_s (%)	ω_f (%)	ϕ_p (deg)	c_p (psf)	ϕ_{LD} (deg)	c_{LD} (psf)	τ_p (psf)	τ_{LD} (psf)	C_{DS-P}	C_{DS-LD}
11A	12 x 12	400	0.04	200	24	400	24			102.4	45	45	42	15	402	291	0.90	0.78
11B	12 x 12																	
11C	12 x 12																	

NOTES:

(1) Sliding (i.e., shear failure) occurred at the interface between GAB material and geotextile side of GCL.

(2) The reported total-stress secant friction angle was defined as $\delta_{secant} = \arctan(\text{shear strength}/\text{normal strength})$. Caution should be exercised in using the secant friction angle for applications involving normal stresses other than the test normal stress. The large-displacement (LD) shear strength was calculated using the shear force measured at the end of the test.

DATE OF TEST: 10/30/2012



SGI TESTING SERVICES, LLC

FIGURE NO.	C-3
PROJECT NO.	SG112006
DOCUMENT NO.	
FILE NO.	



BENTOMAT® CL and CLT GCLs

CETCO LINING TECHNOLOGIES - 2012 ANNUAL SHEARING TEST PROGRAM GCL DIRECT SHEAR TESTING (ASTM D 6243)

Upper Shear Box: Clay soil compacted to approximately 95% of max standard Proctor density at 3% + OMC ($\gamma_{dmax} = 114$ pcf, OMC = 15.0%)
Bentomat CLT GCL with 20 mil textured geomembrane (asperity = 13 mils) with black textured geomembrane side up against clay soil
Lower Shear Box: Concrete sand

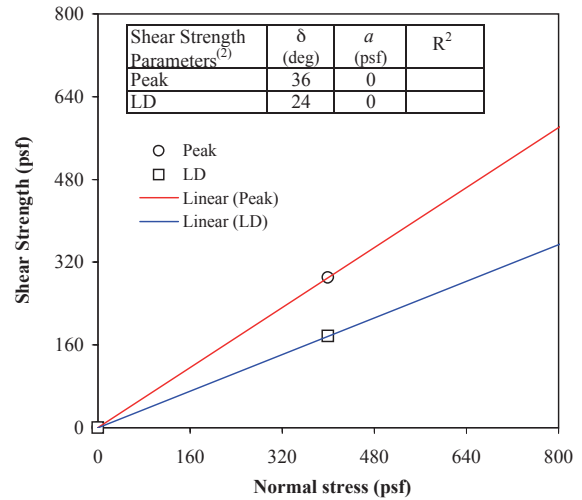
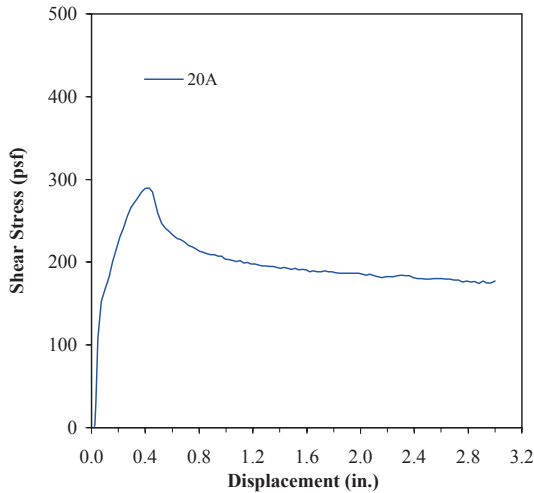

Test No.	Shear Box Size (in. x in.)	Normal Stress (psf)	Shear Rate (in./min)	GCL Soaking		Consolidation		GCL			Soil Shear Strength Parameters				Shear Strength ⁽¹⁾		Coefficient of Direct Sliding	
				Stress (psf)	Time (hours)	Stress (psf)	Time (hours)	ω_1 (%)	ω_3 (%)	ω_F (%)	ϕ_P (deg)	c_P (psf)	ϕ_{LD} (deg)	c_{LD} (psf)	τ_P (psf)	τ_{LD} (psf)	C_{DS-P}	C_{DS-LD}
20A	12 x 12	400	0.04	200	24	400	24			124.2					290	177		
20B	12 x 12																	
20C	12 x 12																	

NOTES:

(1) Sliding (i.e., shear failure) occurred at the interface between clay and textured geomembrane of GCL.

(2) The reported total-stress secant friction angle was defined as $\delta_{secant} = \arctan(\text{shear strength}/\text{normal strength})$. Caution should be exercised in using the secant friction angle for applications involving normal stresses other than the test normal stress. The large-displacement (LD) shear strength was calculated using the shear force measured at the end of the test.



SGI TESTING SERVICES, LLC

DATE OF TEST:	12/15/2012
FIGURE NO.	C-20
PROJECT NO.	SGI12006
DOCUMENT NO.	
FILE NO.	

**CETCO LINING TECHNOLOGIES - 2012 ANNUAL SHEARING TEST PROGRAM
GCL DIRECT SHEAR TESTING (ASTM D 6243)**

Upper Shear Box: Graded aggregate base (GAB) material compacted to approximately 95% of max standard Proctor density at OMC ($\gamma_{dmax} = 137$ pcf, OMC = 5.7%)
Bentomat CLT GCL with 20 mil textured geomembrane (asperity = 13 mils) with black textured geomembrane side up against GAB material
Lower Shear Box: Concrete sanc

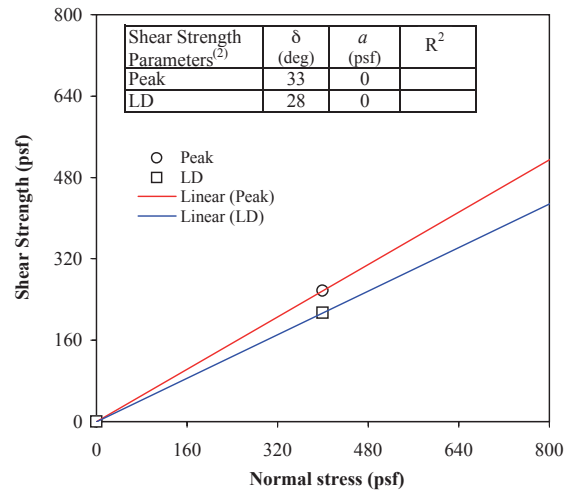
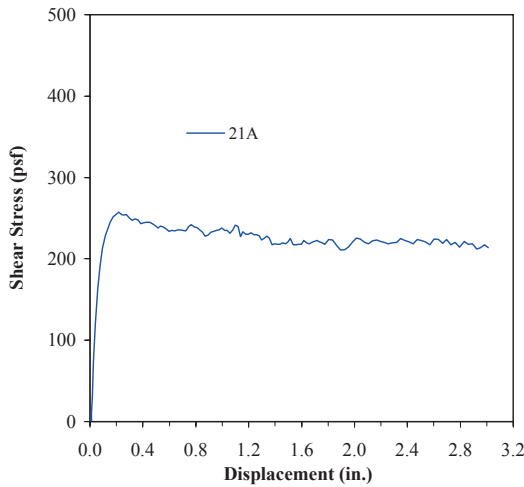

Test No.	Shear Box Size (in. x in.)	Normal Stress (psf)	Shear Rate (in./min)	GCL Soaking		Consolidation		GCL			Soil Shear Strength Parameters				Shear Strength ⁽¹⁾		Coefficient of Direct Sliding	
				Stress (psf)	Time (hours)	Stress (psf)	Time (hours)	ω_s (%)	ω_b (%)	ω_f (%)	ϕ_p (deg)	c_p (psf)	ϕ_{LD} (deg)	c_{LD} (psf)	τ_p (psf)	τ_{LD} (psf)	C_{DS-P}	C_{DS-LD}
21A	12 x 12	400	0.04	200	24	400	24			114.9	45	45	42	15	257	214	0.58	0.57
21B	12 x 12																	
21C	12 x 12																	

NOTES:

- (1) Sliding (i.e., shear failure) occurred at the interface between GAB material and textured geomembrane of GCL.
- (2) The reported total-stress secant friction angle was defined as $\delta_{secant} = \arctan(\text{shear strength}/\text{normal strength})$. Caution should be exercised in using the secant friction angle for applications involving normal stresses other than the test normal stress. The large-displacement (LD) shear strength was calculated using the shear force measured at the end of the test.

DATE OF TEST: 12/15/2012



SGI TESTING SERVICES, LLC

FIGURE NO.	C-21
PROJECT NO.	SGI12006
DOCUMENT NO.	
FILE NO.	



BENTOMAT® CL and CLT GCLs

CETCO LINING TECHNOLOGIES - 2012 ANNUAL SHEARING TEST PROGRAM GCL DIRECT SHEAR TESTING (ASTM D 6243)

Upper Shear Box: Silty sand compacted to approximately 95% of max standard Proctor density at OMC ($\gamma_{dmax} = 98.5$ pcf, OMC = 19.0%)
Bentomat CLT GCL (20 mil textured HDPE geomembrane) with textured HDPE geomembrane side up against silty sand
Lower Shear Box: Concrete sand

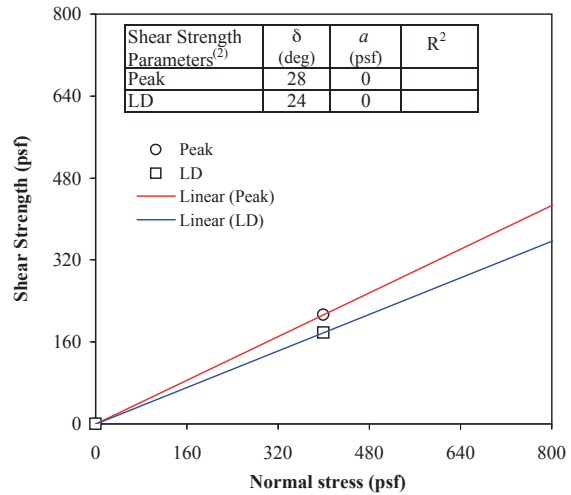
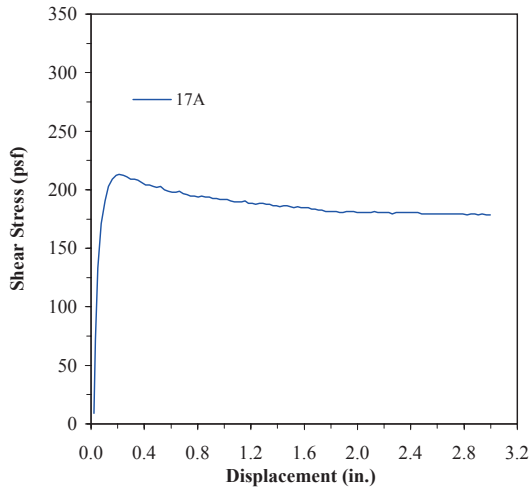

Test No.	Shear Box Size (in. x in.)	Normal Stress (psf)	Shear Rate (in./min)	GCL Soaking		Consolidation		GCL			Soil Shear Strength Parameters				Shear Strength ⁽¹⁾		Coefficient of Direct Sliding	
				Stress (psf)	Time (hours)	Stress (psf)	Time (hours)	ω_1 (%)	ω_3 (%)	ω_r (%)	ϕ_p (deg)	c_p (psf)	ϕ_{LD} (deg)	c_{LD} (psf)	τ_p (psf)	τ_{LD} (psf)	C_{DS-P}	C_{DS-LD}
17A	12 x 12	400	0.04	200	24	400	24			120.6	32	75	31	30	213	178	0.66	0.66
17B	12 x 12																	
17C	12 x 12																	

NOTES:

- (1) Sliding (i.e., shear failure) occurred at the interface between silty sand and textured geomembrane f GCL.
- (2) The reported total-stress secant friction angle was defined as $\delta_{secant} = \arctan(\text{shear strength}/\text{normal strength})$. Caution should be exercised in using the secant friction angle for applications involving normal stresses other than the test normal stress. The large-displacement (LD) shear strength was calculated using the shear force measured at the end of the test.



SGI TESTING SERVICES, LLC

DATE OF TEST:	11/23/2012
FIGURE NO.	C-1
PROJECT NO.	SGI12006
DOCUMENT NO.	
FILE NO.	





cetco@mineralstech.com | cetco.com | 800.527.9948

UPDATED: JULY 2020

© 2015 CETCO. IMPORTANT: The information contained herein supersedes all previous printed versions, and is believed to be accurate and reliable. For the most up-to-date information, please visit www.cetco.com. CETCO accepts no responsibility for the results obtained through application of this product. All products are sold on the understanding that the user is solely responsible for determining their suitability for the intended use and for proper use and disposal of the product. CETCO MAKES NO WARRANTY OF MERCHANTABILITY OR SUITABILITY FOR ANY PARTICULAR PURPOSE IN CONNECTION WITH ANY SALE OF THE PRODUCTS DESCRIBED HEREIN. CETCO reserves the right to update information without notice.

