

SWELLTITE®

COMPOSITE BENTONITE WATERPROOFING SYSTEM



SWELLTITE® COMPOSITE BENTONITE WATERPROOFING SYSTEM

CONTENTS

- SECTION 1: PRODUCT DESCRIPTION**
- SECTION 2: TYPICAL APPLICATIONS**
- SECTION 3: PERFORMANCE CHARACTERISTICS**
- SECTION 4: ACCESSORY PRODUCTS**
- SECTION 5: GENERAL GUIDELINES**
- SECTION 6: HORIZONTAL MEMBRANE INSTALLATION**
- SECTION 7: DECK DETAILING**
- SECTION 8: CONCRETE WALL INSTALLATION**
- SECTION 9: MASONRY BLOCK WALL INSTALLATION**
- SECTION 10: GRADE TERMINATION**

SECTION 1 PRODUCT DESCRIPTION

SWELLTITE is a waterproofing membrane composite consisting of a thick layer of sodium bentonite compound integrally bonded between a tough geomembrane liner and a clear poly siliconized release liner. SWELLTITE is manufactured at a factory controlled 2.0 mm (80-mil) thickness. Roll size is 1.02 m x 11.5 m (40" x 37' 9"); 11.5 sq m (125 square feet).

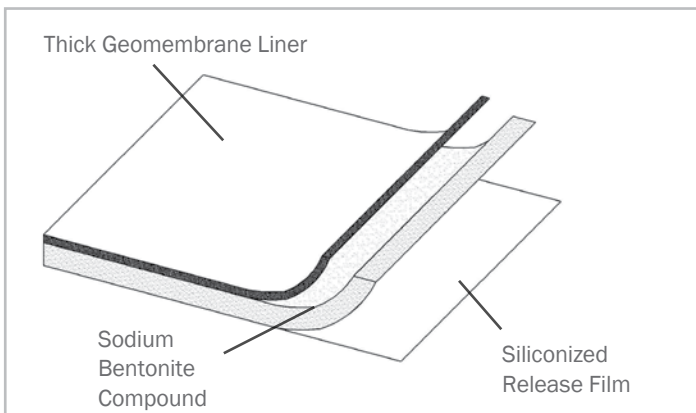

SWELLTITE Composite

SECTION 2 TYPICAL APPLICATIONS

SWELLTITE is designed for waterproofing below-grade vertical and horizontal structural surfaces, as well as, above grade split-slab construction used with plaza areas, parking garages and sports stadiums. SWELLTITE is excellent for below-grade masonry block walls and cut-and-cover tunnels.

- Split-slab Plaza Deck Construction
- Cut & Cover Tunnels
- Masonry Block Foundation Walls
- Concrete Foundation Walls
- Earth-covered Structures

SECTION 3 PERFORMANCE CHARACTERISTICS

SWELLTITE is a dual waterproofing composite that combines the strength and puncture resistance of a geomembrane liner with the proven active waterproofing of sodium bentonite. SWELLTITE has been successfully tested by independent laboratories to resist over 61 m (200 feet) of hydrostatic pressure.

The flexible, tough geomembrane liner functions as both the first layer of waterproofing and a protection course. The geomembrane liner protects the bentonite compound from inclement weather and possible construction related damage. At the liner seams, the sodium bentonite compound reacts with the water and swells. This swelling effectively seals off the water and prevents it from penetrating the structure or moving laterally behind the liner.

SWELLTITE is a true advancement in waterproofing membrane technology. It works by forming a monolithic membrane upon hydration with water. When wetted, unconfined bentonite can swell up to 15 times its dry volume. When confined under pressure the swell is controlled, forming a dense, impervious waterproofing membrane. The swelling action of the bentonite compound can seal small concrete cracks caused by ground settlement, concrete shrinkage, or seismic action; problems over which there is normally no control.

SECTION 4 ACCESSORY PRODUCTS

M-2000 Liquid Flashing®: M-2000 Liquid Flashing is a trowel-grade waterproofing mastic used as a detailing product around penetrations, drains and at corner transitions for horizontal deck and vertical wall installations. M-2000 Liquid Flashing is a single-component moisture curing elastomer that meets the requirements of ASTM C836-84.

BENTOSEAL®: BENTOSEAL is a trowel grade sodium bentonite mastic used as a detailing mastic around penetrations and at corner transitions for below-grade wall installations.

A-3000WB Adhesive®: Water-based latex adhesive applied to substrates to promote adhesion of SWELLTITE Membrane. Typical application rate 25 sq m (250–275 sq ft/gallon).

SEAMTAPE: Tape used to seal SWELLTITE overlap seams.

WATERSTOP-RX®: WATERSTOP-RX is a flexible, expanding strip WATERSTOP designed for nonmoving concrete construction joints. WATERSTOP-RX is not a self-adhering product. Use CETSEAL to secure it into place.

AQUADRAIN®: Subsurface drainage composites consisting of high impact, 3-dimensional polystyrene core and a filter fabric. AQUADRAIN provides a consistent positive drainage flow rate in both vertical and horizontal applications. Its thin profile and high compressive strength make it ideal for split-slab construction.

ENVIROSHEET: Self-adhering flashing membrane for grade terminations.

CETSEAL: Single-component polyether general sealant and adhesive.

SECTION 5 GENERAL GUIDELINES

SURFACE PREPARATION

Structural concrete surfaces should be smooth and free of dirt, rock, debris, oil, grease, laitance, or other foreign materials. Remove form fins and other protrusions to match monolithic surface. Completely fill any honeycombing, voids, and cracks with non-shrink cementitious grout, M-2000 or BENTOSEAL. Thru-wall form-tie holes should be completely filled with non-shrink cementitious grout with a plug of WATERSTOP-RX placed in the center. Concrete surfaces to receive M-2000 should be water cured a minimum of 7 days prior to application. Where possible, design horizontal concrete surfaces with proper slope to drain.

WEATHER CONDITIONS

Install SWELLTITE only in dry weather. Installation should not proceed when work areas are flooded or excessively wet, nor when rain can be reasonably anticipated before SWELLTITE can be properly covered.

FLOOD TESTING

Flood testing of SWELLTITE is not required, nor recommended. When a flood test is specified, consult manufacturer for any special installation instructions that may be applicable.

BACKFILL / TOPPING MATERIAL REQUIREMENTS

SWELLTITE requires proper containment from compacted backfill or topping ballast material. On decks, SWELLTITE requires a minimum 75 mm (3") thick reinforced concrete slab or a minimum paver assembly (includes sand or grout leveling course) weight of 9 kg (20-lbs) per square foot. Compactable soil topping must be a minimum 450 mm (18") thick and compacted to a minimum 85% proctor density.

STORAGE & HANDLING

Store product in dry location protected from construction operations and weather. Protect waterproofing materials from moisture, excessive temperatures and prolonged exposure to direct sunlight during storage. Provide cover, top and all sides (allow for adequate ventilation), for materials stored on-site. Do not double stack pallets.

LIMITATIONS

SWELLTITE should only be installed after proper substrate preparation has been completed and is suitable to receive the waterproofing system. Concrete work should use conventional cast-in-place forms that produce a smooth surface. Do not use stay-in-place concrete forming; use removable forming products only.

Do not use product without proper backfill or topping slab confinement. SWELLTITE is not designed for unconfined above-grade waterproofing applications or subsurface applications that do not provide full confinement coverage. Do not install SWELLTITE on horizontal plaza deck applications that utilize pavers placed on pedestals.

SWELLTITE is not designed to waterproof expansion joints. Expansion joints require a properly engineered expansion joint product.

Do not install SWELLTITE in standing water or during precipitation. If ground water contains strong acids, alkalis or is of a conductivity of 2,500 µmhos or greater, submit water samples to the manufacturer for compatibility testing. Consult CETCO for special installation guidelines that apply to shotcrete and precast concrete construction.

SWELLTITE® COMPOSITE BENTONITE WATERPROOFING SYSTEM

SECTION 6 HORIZONTAL MEMBRANE INSTALLATION

Before installing the membrane, prepare substrate, and detail all drains, transition corners and penetrations.

MEMBRANE INSTALLATION

REMOVE CLEAR RELEASE FILM from back of membrane before installation. Install membrane with bentonite compound against the structure (white liner side up) from the low point to the high point across the fall line to create a shingle style installation. Overlap all membrane edges a minimum of 50 mm (2"). Stagger membrane roll end seams a minimum 300 mm (12"). Seal all membrane overlap seams with CETCO Seam-tape.

Cut membrane to closely fit around penetrations overlapping previously installed M-2000. Trowel 1.5 mm (60-mil) thick counter flashing of M-2000 over membrane edge around penetrations, drains, and elevation changes. Seal all membrane overlap seams with CETCO Seamtape (see Figure 8).

Optional Adhesive Method: Apply A-3000WB Adhesive by roller or sprayer at a rate of 25 sq m per 3.8 l (250–275 sq ft per gallon) and allow to cure (dry black) before applying membrane. After adhesive has cured, follow membrane installation instructions above. Primed surfaces not covered by membrane during same working day must be re-primed.

Consult manufacturer if deck is precast concrete planks or for other conditions not stated herein.

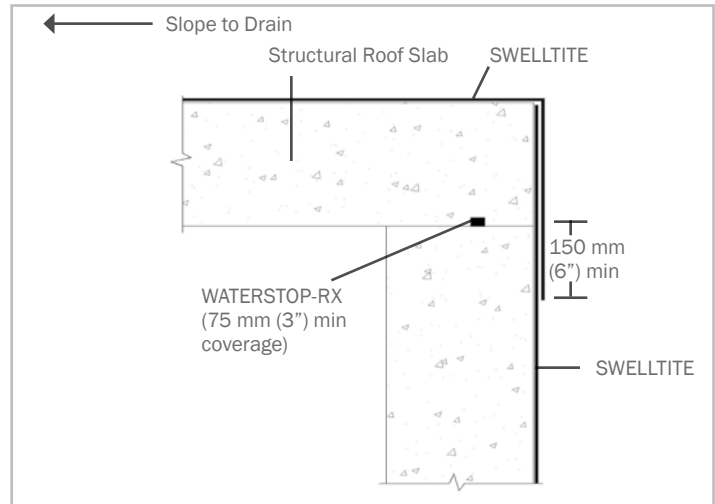

Figure 2 – Horizontal to vertical detail

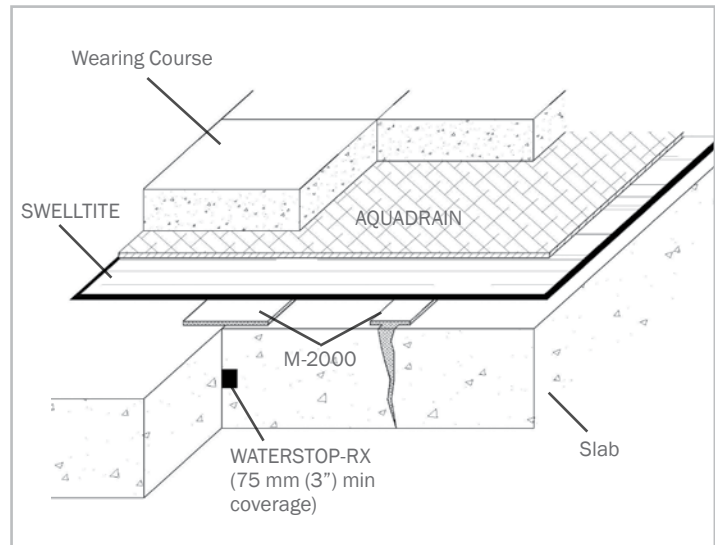

Figure 3 – Horizontal joint and crack detail

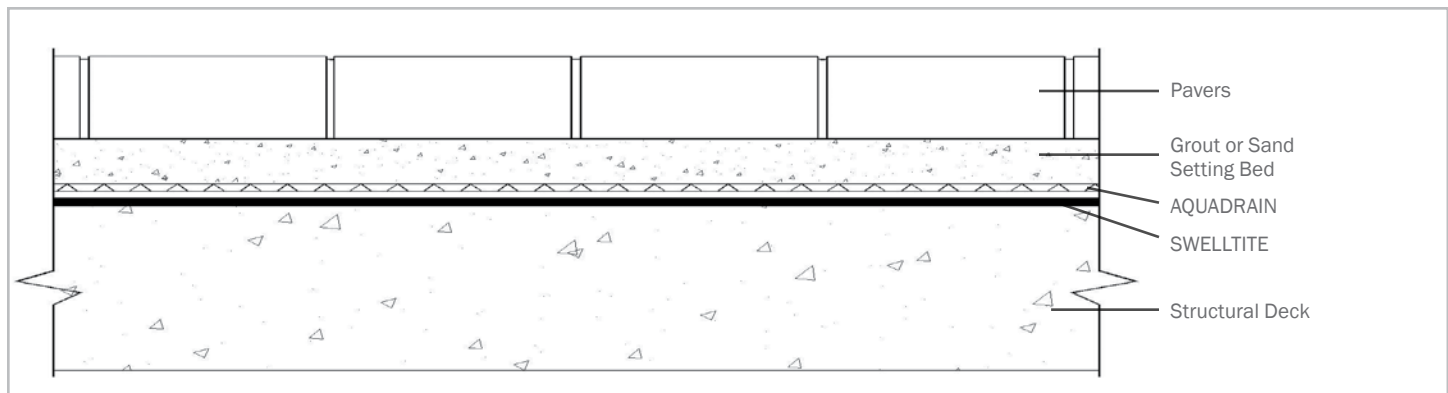

Figure 4 – Typical paver plaza deck detail

SECTION 7 DECK DETAILING

Before installing the membrane, prepare substrate, and detail all drains, transition corners and penetrations.

DRAINS

Trowel a minimum 2.3 mm (90-mil) thick layer of M-2000 on the drain ring and continuing into the drains inward throat slope. Extend M-2000 a minimum of 150 mm (6") around the drain (see Figure 5). Allow M-2000 to cure a minimum of 12 hours prior to installing membrane. After SWELLTITE is installed to contour drain, apply a 1.5 mm (60-mil) thick layer of M-2000 to counter flash membrane edge.

PENETRATIONS

Trowel a minimum 19 mm (3/4") cant of M-2000 around the penetration. Extend M-2000 outward from penetration a minimum of 150 mm (6") at 2.3 mm (90-mil) thick (see Figure 6). After membrane has been installed overlapping M-2000 50 mm (2"), apply a 1.5 mm (60-mil) thick counter flashing of M-2000 at the membrane edge.

TRANSITION CORNERS

Apply a 19 mm (3/4") thick M-2000 fillet to inside transition corners. Then extend M-2000 at 2.3 mm (90-mil) minimum thickness for 150 mm (6") in both directions from the corner (see Figure 7). Allow M-2000 to cure a minimum of 12 hours prior to installing membrane. After membrane has been installed to the corner, apply a 1.5 mm (60-mil) thick counter flashing of M-2000 or CETSEAL to cover the membrane edge.

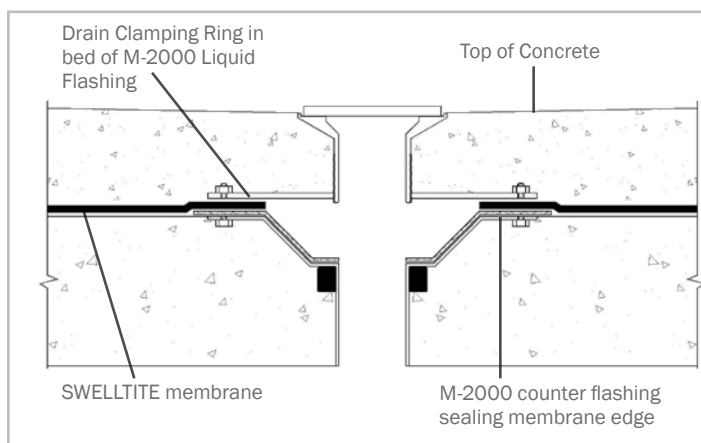

Figure 5 - Deck drain detail. CETCO recommends using a double stage drain for all deck drains.

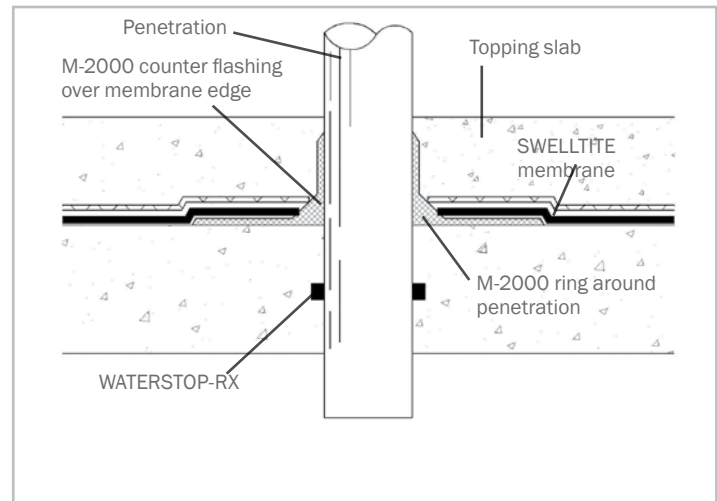

Figure 6 - Deck penetration detail

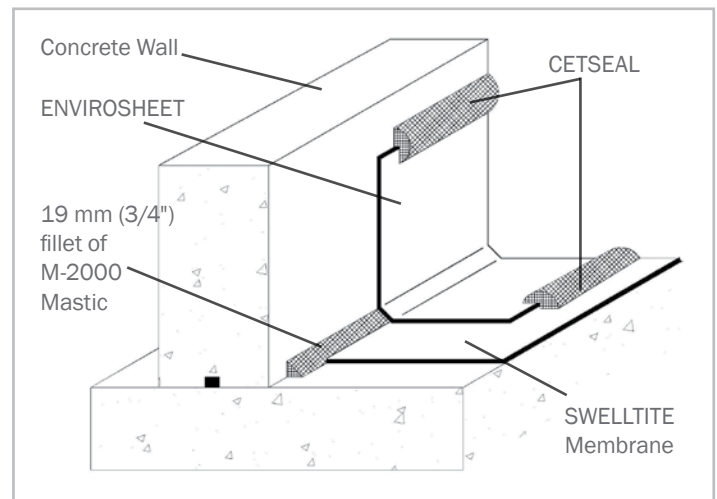

Figure 7 - Deck to wall inside corner detail

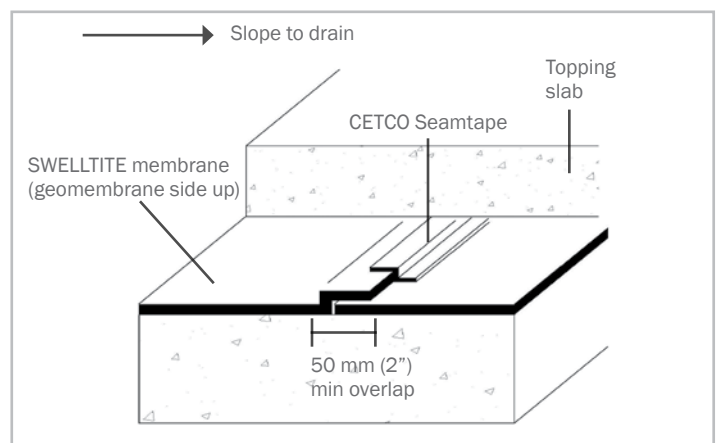

Figure 8 - Horizontal membrane overlap detail

SWELLTITE® COMPOSITE BENTONITE WATERPROOFING SYSTEM

SECTION 8 CONCRETE WALL INSTALLATION

Before installing the membrane, prepare substrate, and detail all drains, transition corners and penetrations.

VERTICAL INSIDE CORNERS

Install a 19 mm (3/4") thick, continuous fillet of BENTOSEAL or M-2000 mastic at all vertical inside corners.

PENETRATIONS

Apply a 19 mm (3/4") thick fillet of BENTOSEAL or M-2000 mastic around base of penetrations. Extend mastic a minimum of 150 mm (6") outward from penetration 2.3 mm (90-mil) thick. After SWELLTITE membrane is installed, apply a counter flashing of BENTOSEAL at membrane edge around penetration.

FOOTING/WALL JOINT

Install at footing/wall joint a continuous 19 mm (3/4") thick, 45° angle fillet of BENTOSEAL or M-2000 mastic.

MEMBRANE INSTALLATION

REMOVE CLEAR RELEASE FILM from back of membrane before installation. Starting at the base of the wall, install the membrane over the BENTOSEAL or M-2000 mastic cant and onto the footing a minimum of 150 mm (6") with bentonite compound directly against the wall (white liner side toward installer). Secure membrane with washer-head fasteners maximum 600 mm (24") on center or less as required along the membrane edges. Overlap all membrane edges a minimum 50 mm (2"). Stagger membrane roll end seams a minimum 300 mm (12"). SWELLTITE membrane may be installed either horizontally or vertically oriented. Seal all overlap seams with CETCO Seamtape.

Cut membrane to closely fit around penetrations. Trowel a minimum 19 mm (3/4") thick layer of BENTOSEAL or M-2000 mastic around penetrations. Extend BENTOSEAL or M-2000 mastic onto penetration and completely fill area between membrane edge and penetration. Membrane should not be left exposed for prolonged periods of time). Continue membrane installation to finished grade detail and terminate membrane at finished grade per section 10 herein. Seal all overlap seams with CETCO Seamtape (see Figure 13).

Optional Adhesive Method: Apply A-3000WB Adhesive by roller or sprayer at a rate of 25 sq m per 3.8 l (250–275 sq ft per gallon) and allow to cure (dry black) before applying membrane. After adhesive has cured, follow membrane installation instructions above without the mechanical fasteners. Primed surfaces not covered by membrane during same working day must be re-primed.

Note: When hydrostatic conditions exist, the vertical waterproofing should continuously overlap the underslab waterproofing a minimum 150 mm (6") (see Figure 11).

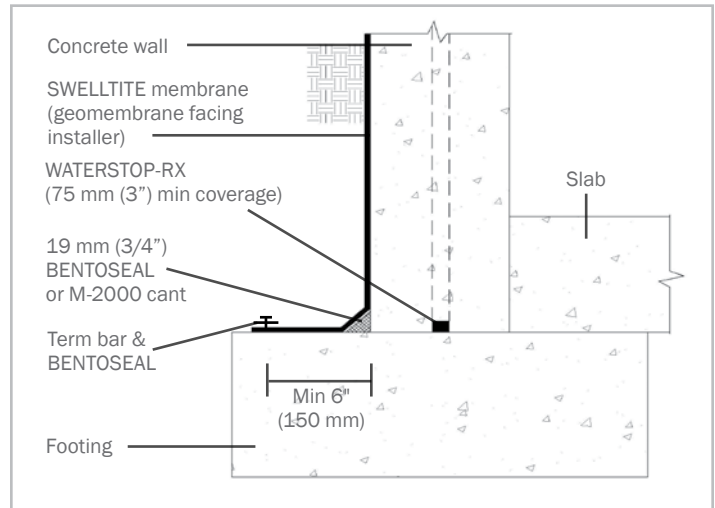

Figure 9 – Concrete wall/footing joint (non-hydrostatic)

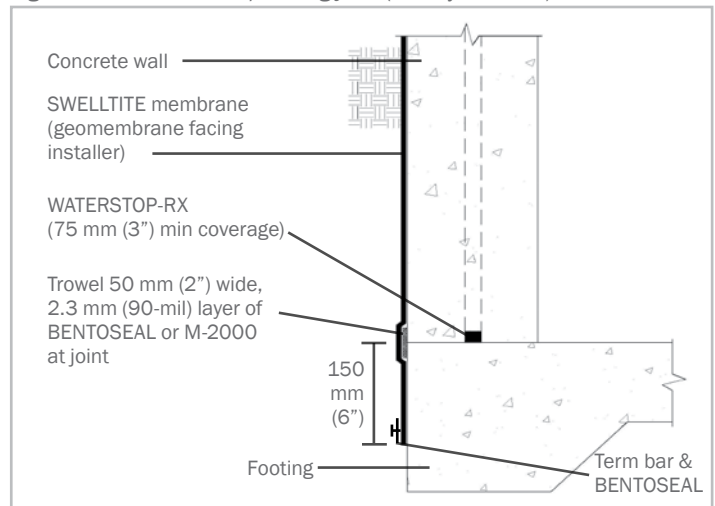

Figure 10 – Concrete wall with flush footing surface

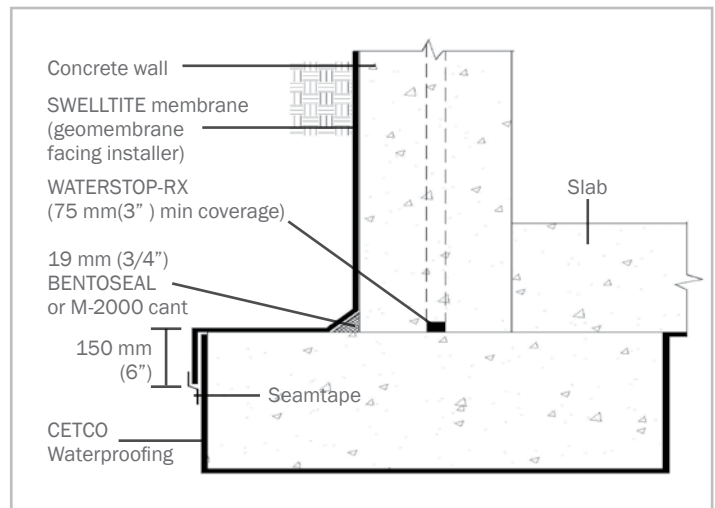

Figure 11 – Concrete wall-footing joint (hydrostatic)

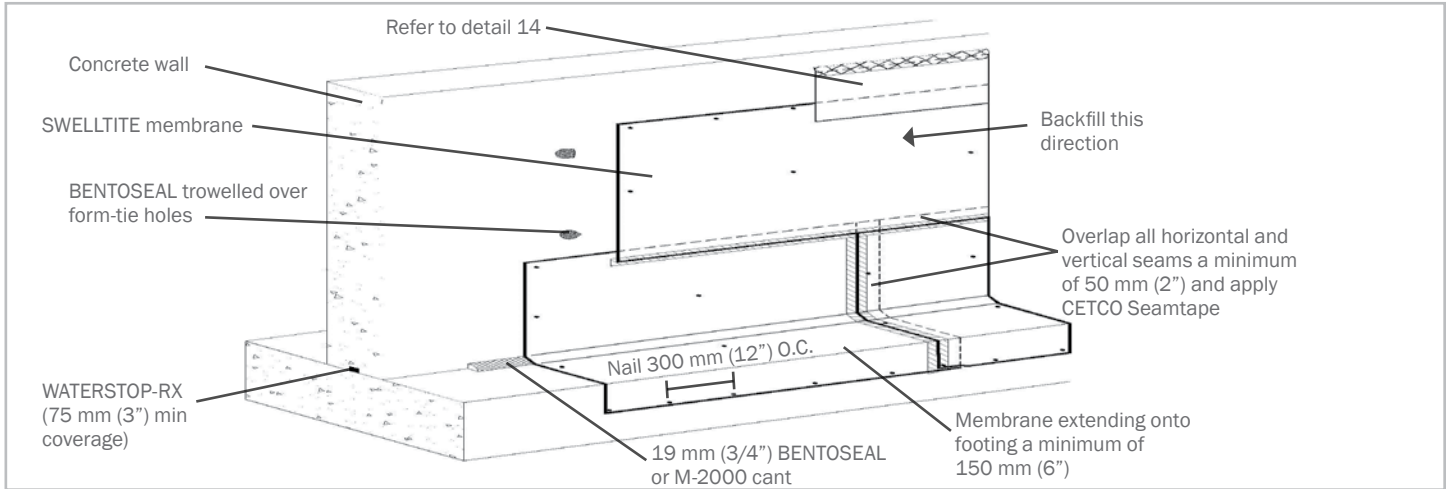

Figure 12 – Foundation wall detail (non-hydrostatic condition)

SECTION 9: MASONRY BLOCK WALL INSTALLATION

CETCO recommends that the masonry block cells be filled with cementitious grout or concrete. All mortar joints should be completely filled and struck flush before membrane is installed to masonry block walls (see Figure 13). Detail all vertical inside corners, penetrations and footing/wall joints per Section 8, Concrete Wall Installation.

Starting at the wall/footing intersection, install bottom course of SWELLTITE horizontally (see Figure 12) with bentonite compound toward the structure (geomembrane facing installer). Membrane should extend over BENTOSEAL or M-2000 mastic cant and onto footing a minimum of 150 mm (6"). All succeeding membrane lifts may be installed either horizontally or vertically. Overlap all membrane edges a minimum 50 mm (2"). Stagger membrane roll end seams a minimum 300 mm (12").

Secure membrane with mechanical fasteners or A-3000WB Adhesive following installation instructions in Section 8, Concrete Wall Installation. Terminate membrane at finished grade per Section 10 herein.

Install CETCO Seamtape centered over all membrane overlap seams (see Figure 13).

SECTION 10 GRADE TERMINATION

Terminate SWELLTITE membrane 300 mm (12") below finished grade elevation with washer-head fasteners maximum 300 mm (12") on center. Install ENVIROSHEET flashing to concrete substrate with bottom edge overlapping top edge of SWELLTITE membrane minimum 100 mm (4"). Overlap all roll ends a minimum 100 mm (4") to form a continuous flashing. Height of flashing shall be per project details and specifications. Install a rigid termination bar along top edge of ENVIROSHEET; fastened maximum 300 mm (12") on center. Complete grade termina-

tion detail with tooled bead of CETSEAL along the top edge, at all penetrations through the flashing and all exposed overlap seams. Backfill material should be placed and compacted to 85% Modified Proctor density immediately following the application of the membrane. If backfill cannot be applied immediately, protect membrane edges from precipitation with CETCO Seamtape. If backfill contains sharp or irregular material, cover membrane with CETCO approved protection material course to avoid damage during backfilling and compaction.

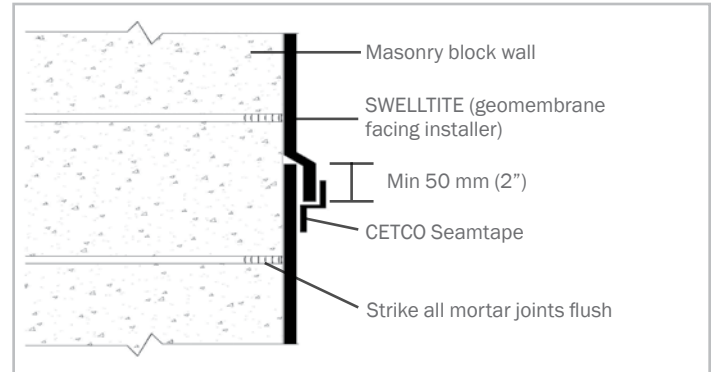

Figure 13 – Masonry wall joint detail

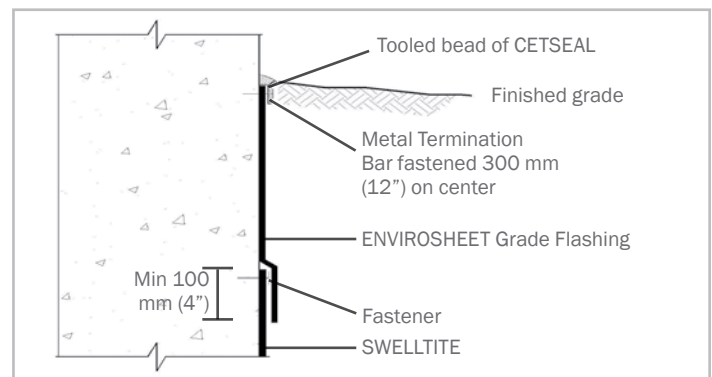

Figure 14 – Vertical wall grade termination



www.cetco.com | contact@cetco.com

UPDATED: JANUARY 2016

© 2016 CETCO. IMPORTANT: The information contained herein supersedes all previous printed versions, and is believed to be accurate and reliable. For the most up-to-date information, please visit www.cetco.com. CETCO accepts no responsibility for the results obtained through application of this product. CETCO reserves the right to update information without notice.

FORM: PM_SWELLTITE_AM_EN_201601_V2

